



2nd edition

Company's Logos

MORFEUS VENTUS20S VENTUS25S/T

THORAX

Aura₂

Force₂

| | | | |
|---|-----------|----------|-------|
|  | Aphrodite | Poseidon | Irene |
|---|-----------|----------|-------|

| | | |
|--|--------------|--------------------|
|  | MySpO2 | SENSE ₂ |
| | MySpO2 watch | |

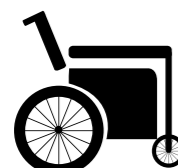
| | | | | | | |
|---|-------|---------|--------|---------|---------|--------|
|  | Basic | Profit | Solid | Golden | Gemini | Elit |
| | Aqua | Convert | Venere | Phidias | Comfort | Cronus |

| | | | |
|---|---------|-------|-------|
|  | Pegasus | Atlas | Talos |
|---|---------|-------|-------|

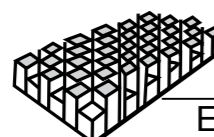
| | | | |
|---|----------|----------|-------------|
|  | Cozy | Gel Tech | Gel Tech 3D |
| | Ergolite | Comfy | Dynamic |

Company's Certificates

INTERNATIONAL
PRESTIGE NOTIFIED
BODIES APPROVALS



NATIONAL EVALUATION OF QUALITY AND TECHNOLOGY IN HEALTH SA
TECHNICAL SUPPORT & MAINTENANCE FOR BREATHING MEDICAL DEVICES



IO-Net
OCCUPATIONAL HEALTH AND SAFETY MANAGEMENT SYSTEM
OHSAS 18001:2007
QA-C-510B/12



KEF_{TPED} / A-C-007B/2015
PERIODIC INSPECTION OF CYLINDERS



NATIONAL EVALUATION OF QUALITY AND TECHNOLOGY IN HEALTH SA
DISTRIBUTION OF MEDICAL DEVICES



NATIONAL EVALUATION OF QUALITY AND TECHNOLOGY IN HEALTH SA
QUALITY MANAGEMENT SYSTEM



ΕΘΝΙΚΟ ΚΕΝΤΡΟ ΑΞΙΟΛΟΓΗΣΗΣ ΤΗΣ ΠΟΙΟΤΗΤΑΣ & ΤΕΧΝΟΛΟΓΙΑΣ ΣΤΗΝ ΥΓΕΙΑ Α.Ε.
NATIONAL EVALUATION CENTER OF QUALITY & TECHNOLOGY IN HEALTH S.A.

EU CERTIFICATE No 301011029C
Manufacture and final inspection of respiratory devices and oxygen therapy products



MANUFACTURERS REGISTER FOR CLASS I ORTHOPAEDIC PRODUCTS



PRODUCTION OF MEDICAL OXYGEN



ISO 9001:2008
Cert No:37939
QUALITY MANAGEMENT SYSTEM



Management System
ISO 14001:2004
Valid until:
2017-01-30
www.tuv.com
ID 9105040871



ENVIROMENTAL MANAGEMENT SYSTEM

International Sales Network

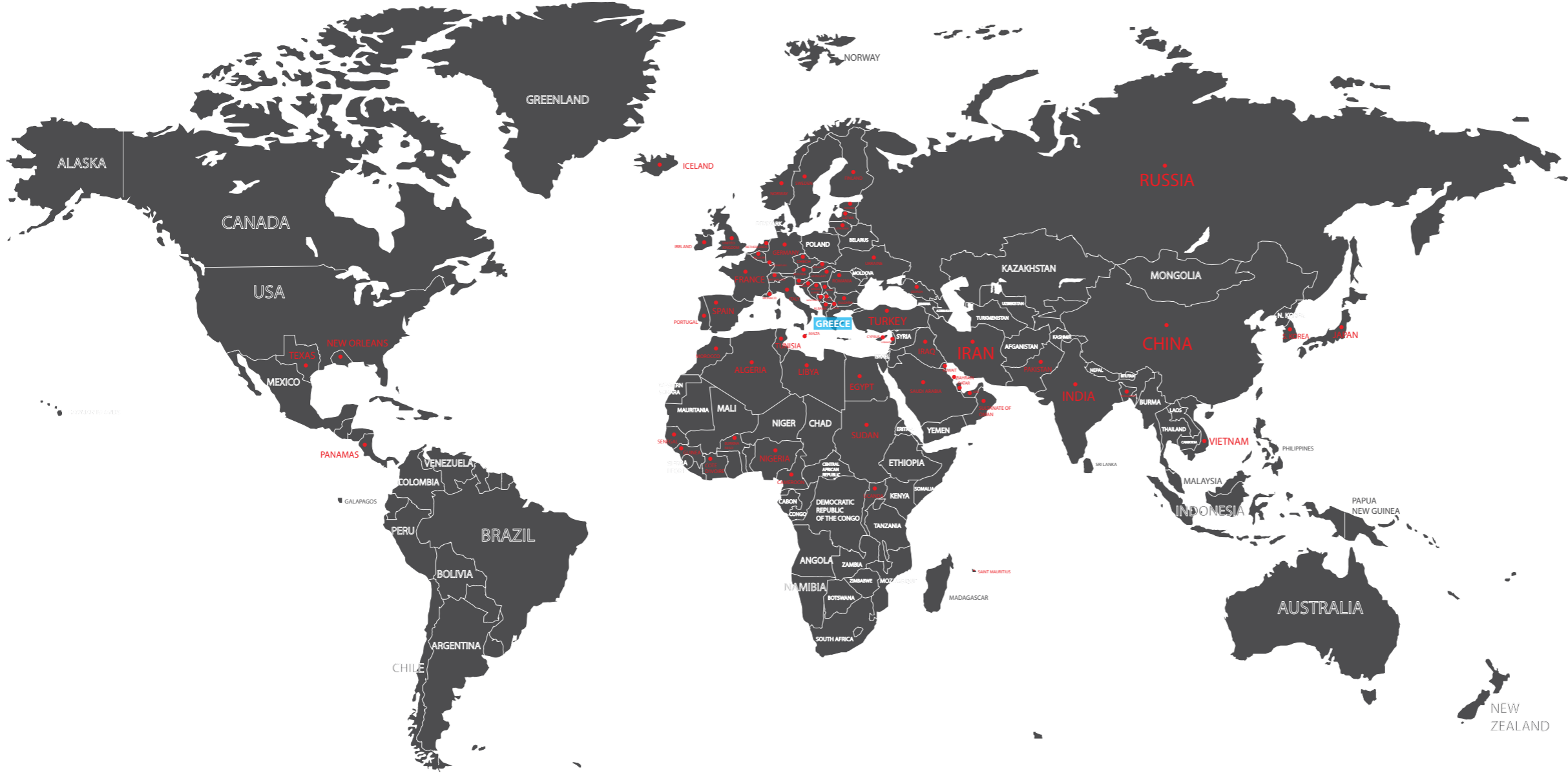

AMERICA
NEW ORLEANS
PANAMAS
TEXAS

EUROPE
ALBANIA
AUSTRIA
BELGIUM
BOSNIA
BULGARIA
CROATIA
CYPRUS
CZECH
ESTONIA
FINLAND
FRANCE
FYROM
GERMANY
HUNGARY
ICELAND
IRELAND
ITALY
KOSOVO
LATVIA
LITHUANIA
LUXEMBURG
MALTA
MONACO
MONTENEGRO
NETHERLANDS
NORWAY
PORTUGAL
ROMANIA
RUSSIA
SERVIA
SLOVAKIA
SLOVENIA
SPAIN
SWEDEN
SWITZERLAND
TURKEY
UKRAINE
UNITED KINGDOM

MIDDLE EAST
BAHRAIN
KUWEIT
LEBANON
PAKISTAN
QATAR
SAUDI ARABIA
SULTANATE OF OMAN
UNITED ARAB EMIRATES

AFRICA
ALGERIA
BURKINA FASO
CAMEROON
CÔTE D'IVOIRE
EGYPT
GUINEA
LIBYA
MAURITIUS
MOROCCO
NIGERIA
UGANDA
SENEGAL
SUDAN
TUNISIA

ASIA
BANGLADESH
CHINA
INDIA
IRAQ
IRAN
JAPAN
KOREA
VIETNAM

Value in safety..
Invest in Quality!

Welcome to the world of MOBILAK

CHANIA CRETE

Central Premises in Chania, Crete (Kathiana Region, Aktrotiri 7000m²)



Liquid & Air Sector - Production and Bottling Facilities

Cryogenic Tanks are shown in the photo
(3 Oxygen, 1 Nitrogen, 1 Argon, 2 Carbon Dioxide)



Hydraulic 6-Position Testing Machine for Gases & Cylinders
Maximum Production Capacity of 30 Cylinders per Hour - Maximum Test Pressure 450bar



Chemical Laboratory
Equipped with Quality Control, Gas Analysis Analysis Instruments



Automatic Gas Bottling Unit (Medical and Industrial Oxygen, Nitrogen, Argon, CO₂, Mixtures e.g. IG 541, IG 55, Banarg etc.)



Valve Fitting Machine for Gas Cylinders



Drying Facility for Cylinders and Extinguishers, following the Hydraulic Test Procedure



MOBIAK Facilities in China



MOBIAK Balkans Distribution Center (F.Y.R.O.M)



Central Greece, Europe, Cyprus, Egypt and Middle East distribution center in Athens



North Greece, Balkans, Europe distribution center in Thessaloniki



Exhibition - Showroom Chania Branch



Central & Eastern Crete distribution center in Heraklio



Central & Western Crete distribution center in Chania



Central & Eastern Crete Distribution Center (Industrial Zone of Heraklion, Crete)



Show Room - Athens



Show Room - Athens



Council Chamber - Product Showroom



President's Office



Equipment for oxygen purity & pressure checking of Medical Devices



Checking and repair of Respiratory devices

ASPROPIRGOS ATTICA - ATHENS

Central, South, & Insular Greece Distribution Center (Aspropirgos, Magoula, Attica - Athens 4.000m²)



MOBIAK
fire fighting

ATHENS DISTRIBUTION CENTER

MOBIAK S.A.
FIRE FIGHTING

MOBIAcare
ULTRAVERTICAL SYSTEMS



KALOCHORI THESSALONIKI

N. Greece - Balkan Area Distribution Center (8 Arkadiou Str., Kalochori, Thessaloniki 5.000m²)



Sales Department

Any time our sales team is available for your convenience, through email at medicalexports@mobiak.gr, or through Fax: **+30 28210 66403** or call **+30 28210 63222**.



CHOUDALAKIS GEORGE
int. 309

Technical Support



BINAKIS VASSILIS
Phone **+30 28210 63222**
int. 314

This is Vasilis Binakis from our MOBIKACARE Technical Support Department . I am always available for any questions and concerns you have on your breathing devices.

Reliable, fast and efficient Technical Support under the auspices of a brand name you know and trust for years, «MOBIK SA» I am always available to inspect the damage and your problems in order to help you troubleshoot on your own, without the need to move your devices.

Training

We can provide training in our facilities, fast and free of charge, which will enable you to perform repairing tasks and save money for your company.

And do not forget, I'm the person behind every telephone call you make to our Mobicare Technical Support.



You can contact me to feel the confidence of the Technical Support behind MOBIK

Technical Support in 5 Locations

1 **FACTORY - RETAIL DEPARTMENT**
KATHIANA AKROTIRI, CHANIA - CRETE 731 00, Tel: 28210 63222 fax: 28210 66403

2
HEADQUARTERS
96-98 M. MPOTSARI STR., CHANIA - CRETE 731 36
Tel: 28210 91561, 28210 91661

4
CENTRAL - SOUTH & ISLAND GREECE DISTRIBUTION CENTER
ASPROPIRGOS, MAGOULA - ATTICA, ATHENS 193 00
Tel: 210 4614006

3
N. GREECE - BALKANS, DISTRIBUTION CENTER
8 ARKADIOU STR., KALOCHORI- THESSALONIKI 570 09
Tel: 2310 785668

5
CENTRAL & EASTERN CRETE DISTRIBUTION CENTER
INDUSTRIAL ZONE OF HERAKLION - CRETE 716 01
Tel: 2810 333151

Our Website www.mobiakcare.gr

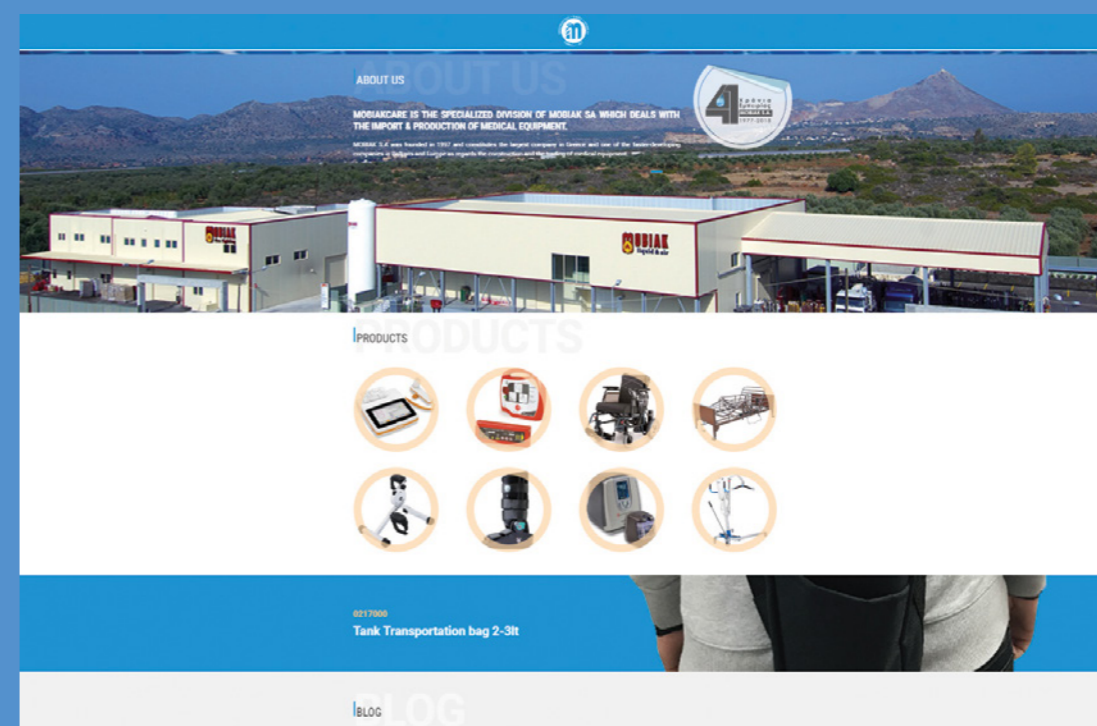

A website open to the whole world!

User Functions:

- MOBIKACARE catalogue in different languages
- Product Presentation
- Search products by category
- Technical Information of Products and Photos
- Company Certificates
- General Product Certificates
- News on Medical Department
- MOBIKPress Journal.
- Educational Videos on Products.
- Information on Health
- Advice on Service
- Contact Form and Order Form

To get full rights to the MOBIKACARE website and place your orders, all you have to do is a simple user registration. For any clarification, please contact the MOBIKACARE Sales Department

page
22 Oxygen Therapy

Medivital - Aphrodite Oxygen Therapy Set/ "Aura" - Thorax 5 - FO2RCE - Irene - Irene Neb Oxygen Concentrator/ Oxygen Analyzer / Oximeter /O2 Sensor/ Oxygen Therapy Consumables, Medical O2 Cylinders - Flowmeters

page
30 Nebulizer Treatment

Gem Nebulizer/ Inhalation Chambers - Nebulizer Treatment Consumables

page
34 Cpap - Bilevel Devices

CPAP Morfeus - Morfeus Soft - Morfeus Auto - Morfeus II Auto / BiLevel Ventus 20 S - 25-S/T / Humidifier

page
39 Masks

Nasal-oro-Nasal Masks

page
40 Aspiration

Aspiration Devices & Catheters

page
22 Diagnostic Devices

MySPO2 - Sense O2 Finger Oximeter/Wrist Oximeter with Recorder MySPO2 Watch / Case / Neonatal-Adult Sensors

page
44 Wheelchairs

Wheelchair Basic - Profit - Solid - Aluminium -Golden - Gemini - Elite - Heavy Duty - Cerebral Palsy -Infant - Reclining - With Commode - ECO - Folding -Indoors - Simple - Bathroom - Electric - Stand / Wheelchair Accessories

page
65 Power Wheelchairs

page
69 Shoprider Scooter

Power Wheelchairs / Power Wheelchairs-Folding / 2-Seater / MaxiCab

page
78 Patient Beds

Single Crank Metal Beds - Multi-Folding / Single Crank Bed One Piece / Height-Fixed Electric Single-Folding Bed / Burmeier Beds / Semi- Electric - Electric Multi-Folding Bed / Hospital Bedside Table/ Bedside Tables

page
92 Tables - Bedside Tables

page
94 Bed Accessories

page
96 Lifts

Patient Lifts / Slings

page
98 Electric Blankets

Single-Double Electric Blanket/ Small Electrical Blanket / Electrical Cushion

page
100 Mattresses-Cushions Covers

Foam Mattress/ Waterproof mattress cover Single-Double/ Waterproof Pillow cover / Sleeping Pillows /Aid Pillows

page
105 Items for bed sore patients

Protector for heel or elbow / Pressure Sore Ring Cushion / Pressure Sore Cushions / New Technology Pressure Sore Cushions /Pressure Sore mattresses

page
114 Toilets - Bathroom Aids

Steel Toilet Fixed - Fixed Folding Toilet - Fixed Reinforced Toilet - Heavy Duty Toilet - Wheeled Folding Toilet - Multi-Use Toilet/ Bathroom Aids

page
122 Walkers

Folding Walker - Folding Walker with Hand Grips - Folding Walker with 2-level Hand Grips- Walker with "Step-By-Step" Motion - Reinforced - Wheeled Folding Walker - Infant Wheeled Walker - Rollator -Dual-Function Rollator - 3-Caster Rollator -Rehabilitation Rollator Walker

page
126 Canes - Forearm Crutches

Forearm Crutches - 4-legs Canes / Large Base Cane - Small Bariatric / Conical Base Cane / Folding Aluminium Cane Black - Folding Cane / Adjustable cane with Stand up Base & Led Flashlight / Wooden / Cane Case / Underarm Crutches / Spare parts

page
134 Orthopedic Products

Bone Fracture Walking Boots/ Knee ROM Brace / AirCast Splint/ Elbow ROM Brace / Arm Sling

page
136 Derooyal Orthoses

Universal Cervical Thoracic Orthosis/ Cervical Thoracic Orthosis (CTO) / Warrior™ Series / PROlign® Lumbar Orthosis / PROlign® EXT Lumbar Orthosis / Ultraalign+® LSO - TLSO / Support Kits

page
144 Rehabilitation-Physiotherapy

Passive Exercise Bike & Static / Exercise Balls / Exercisers* / Kinesiology tapes/ Scissors / Sprays & Creams /Suitcases / First Aid Cream & Spray / Electrolyte - relaxation cream/ Exercise Stretch Bands /Resistance Tubes / Accessories / Exercise Band / Hand Exerciser / Handle / Exercise Putty/Ball / Squeeze Ball

page
154 Examination Tables - Medical Office Equipment

Examination Bed-Reinforced - Wodden - Electric -Folding - Wooden folding with hole - Metal folding examination bed / Companion chair /Step single/ double / reinforced / Ward Screen /X-ray Film Viewers

page
158 Defibrillator - First Aid Kit

Portable Defibrillator / Defibrillator PADS & Pediatric / Car First Aid Kits

- Oxygen Therapy
- Nebulizer Treatment
- Cpap - Bilevel Devices
- Masks
- Diagnostic Devices
- Incontinence Diapers Urology Consumables
- Wheelchairs
- Power Wheelchairs Shoprider Scooters
- Patient Beds Tables-Bedside Tables, Bed Access.
- Lifts
- Electric Blankets
- Mattresses - Pillows - Covers
- Items for bed sore patients
- Toilets - Bathroom Aids
- Walkers
- Canes - Forearm Crutches
- Orthopedic Products
- Orthoses
- Rehabilitation-Physiotherapy
- Examination Tables - Medical Office Equipment
- Defibrillator First Aid Kits

Oxygen Therapy

Aphrodite Oxygen Therapy Set (O₂-filled)



- Ready-to use oxygen therapy sets filled with oxygen with 25E valve-Aphrodite regulator and aluminum (2-5Lt) or steel cylinder (10-50Lt).
- Flow Control Settings: 0 - 0.5 - 1 - 2 - 3 - 4 - 5 - 6 - 7 - 9 - 12 - 15lt
- Warranty: 1 year
- Poseidon Humidifier (optional) (ref. 0807912).

| | Volume(lt) | m ³ | Pressure (bar) | Height(cm) | Weight(Kg) |
|---------------------|------------|----------------|----------------|------------|------------|
| ref. 0808907 | 2 | 0,4 | 200 | 47 | 4,5 |
| ref. 0808908 | 3 | 0,6 | 200 | 60 | 5,9 |
| ref. 0808909 | 5 | 1,0 | 200 | 63 | 9,2 |
| ref. 0808920 | 10 | 2,0 | 200 | 101 | 16,60 |
| ref. 0808921 | 16 | 3,2 | 200 | 85 | 25,7 |
| ref. 0808922 | 50 | 10,0 | 200 | 163 | 67 |

Aluminum Cylinders with Hinge Valve 25E (O₂-filled)



ref. **0202023** 2lt Aluminium Cylinder

ref. **0202024** 3lt Aluminium Cylinder

ref. **0202018** 5lt Aluminium Cylinder



Steel Cylinders with Hinge Valve 25E (O₂-filled)

ref. **0202013** 10lt Steel Cylinder

ref. **0202030** 16lt Steel Cylinder

ref. **0202009** 50lt Steel Cylinder

Table Autonomy of Medical Oxygen Cylinders in relation to flow

| Cylinder | Oxygen Flow | | | | | | | |
|----------|-------------|-----------|-----------|-----------|-----------|-----------|-----------|-----------|
| | 1(lt/min) | 2(lt/min) | 3(lt/min) | 4(lt/min) | 5(lt/min) | 6(lt/min) | 7(lt/min) | 9(lt/min) |
| 2Lt | 6,67 h | 3,33 h | 2,22 h | 1,67 h | 1,33 h | 1,11 h | 0,95 h | 0,74 h |
| 3Lt | 10 h | 5 h | 3,33 h | 2,5 h | 2 h | 1,67 h | 1,43 h | 1,11 h |
| 5Lt | 18,33 h | 9,17 h | 6,11 h | 4,58 h | 3,67 h | 3,06 h | 2,62 h | 2,04 h |

CYLINDER SPECIFICATIONS

| Ref. | Capacity (in water) | Operating pressure | Test pressure | Dimensions (mm) (Height / Diameter) | Dimensions (Neck) | Weight (empty cylinder) | Weight (O ₂ -filled) |
|----------------|---------------------|--------------------|---------------|-------------------------------------|-------------------|-------------------------|---------------------------------|
| 0202023 | 2 Lt | 200 bar | 300 bar | 470 ± 3,6 / 111 ± 0,83 | 25E | 2,8 Kg | 4,5 Kg |
| 0202024 | 3 Lt | 200 bar | 300 bar | 600 ± 4,9 / 111 ± 0,83 | 25E | 3,8 Kg | 5,9 Kg |
| 0202018 | 5 Lt | 200 bar | 300 bar | 630 ± 5,2 / 140 ± 1,05 | 25E | 6,8 Kg | 9,2 Kg |
| 0202013 | 10 Lt | 200 bar | 300 bar | 101 ± 8,5 / 136 ± 1,37 | 25E | 11,5 Kg | 16,6 Kg |
| 0202030 | 16 Lt | 200 bar | 300 bar | 850 ± 10 / 178 ± 1,78 | 25E | 23,0 Kg | 25,7 Kg |
| 0202009 | 50 Lt | 200 bar | 300 bar | 1485 ± 10 / 229 ± 22,9 | 25E | 57 Kg | 72,70 Kg |

Accessories for Medical Oxygen Cylinders

ref. **0217000** Cylinder Carrying bag 2-3lt



ref. **0217047** Cylinder Carrying bag APHRODITE 2LT



ref. **0808721** Oxygen Cylinder Cart

- Easy transportation of 5 & 10Lt Oxygen Cylinders
- Ring Diameter: 16cm



Medical Oxygen Cylinders

Empty Aluminium Cylinders

| | |
|---------------------|------------------------------|
| ref. 0201032 | 2lt Empty Aluminium Cylinder |
| ref. 0201033 | 3lt Empty Aluminium Cylinder |
| ref. 0201031 | 5lt Empty Aluminium Cylinder |



Empty Steel Cylinders

All cylinders are certified according to the Directive 2010/35/EU

| | |
|---------------------|---------------------------|
| ref. 0128044 | 10lt Empty Steel Cylinder |
| ref. 0128036 | 16lt Empty Steel Cylinder |
| ref. 0128028 | 50lt Empty Steel Cylinder |



| | |
|---------------------|-----------------|
| ref. 0216027 | Hinge Valve 25E |
|---------------------|-----------------|



| | |
|---------------------|-------------------------------------|
| ref. 0134001 | Protective Handle for Gas Cylinders |
|---------------------|-------------------------------------|



- To carry 2-10lt gas cylinders
- Plastic

| | |
|---------------------|----------------------------|
| ref. 0216024 | Metal Protection Hinge Cap |
|---------------------|----------------------------|



- Metal Protection Hinge Cap for 2-50lt gas cylinder.

| | |
|---------------------|------------------------------------|
| ref. 0807916 | Aphrodite Medical Oxygen Flowmeter |
|---------------------|------------------------------------|

- Click Type
- Lightweight and easy to use.
- Hinge Valve 25E Required
- Can be used with "Poseidon" humidifier (optional)
- Flow Control Settings 0 - 0.5 - 1 - 2 - 3 - 4 - 5 - 6 - 7 - 9 - 12 - 15lt
- Warranty: 1 year



| | |
|---------------------|-------------------------------|
| ref. 0807912 | Flowmeter Humidifier Poseidon |
|---------------------|-------------------------------|

- Especially designed to be used with Flowmeter 0807916
- Equipped with a lock valve



| | |
|---------------------|--------------------|
| ref. 0807916 | Flowmeter HERCULES |
|---------------------|--------------------|

- Output pressure: 30-80 psi
- CGA992 input type, side entry
- Flowmeter Flow type, 0-15LPM20 ° C
- Bar pressure gauge, max. 400 bar
- Metal flow connector
- CE0653



Oxygen Therapy



ref. **0810330**

5-Level Portable Oxygen Concentrator "Aura"

New Product

- Lightweight, enabling users to go for a walk.
- Features the MobiTrack advanced breath detection algorithm that evaluates the user's breath rate depending on activity level and provides five (5) different oxygen flow options.
- Car power cable and dual battery charger.
- Includes a modern, practical carry case, so discreet that does not resemble a medical device.
- Runs on battery or plugged in.

| | |
|------------------------|---------------------|
| Power consumption (W) | 48 Watt |
| Operating Power (V/Hz) | 100-240VAC 50/60 Hz |
| Battery | 14,8V, 6Ah |
| Battery charging time | 4 hours |
| Concentration (%) | 83-93 |
| Noise Level (dB) | ≤50 |
| Operating Temperature | 5°C ~ 40°C |
| Storage Temperature | -30°C ~ 60°C |
| Weight (kg) | 3.0kg |
| Dimensions (cm) | 24,5 x 13 x 18 |
| Warranty | 2 years |
| Battery Warranty | 6 months |

| Settings | Battery Life | Oxygen Pulse Flow |
|-----------|--------------|-------------------|
| Setting 1 | ≤ 3 hours | 167 ml / min |
| Setting 2 | ≥ 2.5 hours | 333 ml / min |
| Setting 3 | ≥ 2 hours | 500 ml / min |
| Setting 4 | ≥ 2.15 hours | 667 ml / min |
| Setting 5 | ≥ 2 hours | 833 ml / min |

Built-in carrying handle



Freedom... on the move



Available with breathable carrying bag



ref. 0810300

Thorax 5 Oxygen Concentrator

New Product

- Compact design. The practical design of Thorax 5 occupies less space
- Includes a special humidifier platform for additional flexibility. Designed for compatibility with any type of humidifier, featuring an easy-to-use Velcro closure.
- Low maintenance cost.
- Permanent support power cable.
- Advanced Oxygen Purity System of the oxygen sensor A.O.S (Advance Oxygen Sensor).
- Strong metal oxygen outlet, less prone to breakage.

| | |
|--|----------|
| Estimated power consumption | 300 |
| Estimated current flow | 3.0 |
| Power Supply Requirements | 220V±10% |
| Flow rate (L/min) | 0-5 |
| Oxygen Purity (5L/min) | 93±3% |
| Purity Alarm (complies with the European Standard on Oxygen Concentrators for Medical Use) | ≥ 82% |
| Noise Level dB(A) | ≤45 |
| Weight (kg) | 14.2kg |
| Dimensions (cm) | 39×23×60 |
| Warranty | 3 years |

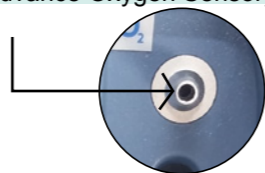

Breathe ..
.. Free

New Generation



ref. 0808194

MOBIAK 5lit Irene Oxygen Concentrator

- Self-Check Mode circuit with clear audiovisual indications of the problem on the digital display.
- Large compressor with a 30% larger cylinder capacity and the best quality Saint-Gobain piston rings.
- Optional flame trap, which prevents the spread of fire in case of smoking.
- Advanced Oxygen Purity System of the oxygen sensor A.O.S (AdvanceOxygen Sensor).

| | |
|------------------------|--|
| Power consumption (W) | 480 |
| Operating Power (V/Hz) | 230 ± 10% / 50 ± 1 |
| Flow Rate (l/min) | 1-5 |
| Concentration (%) | 93 ± 3 |
| Noise Level (dB) | ≤40 |
| Net Weight (Kg) | 24 Kg |
| Dimensions (mm) | 390x337x620 |
| Oxygen Alarm | Activated when the concentration purity of the oxygen delivered is less than 82% |
| Warranty | 3 years (IRENE) |

Available upon request

ref. 0810001

MOBIAK Irene Neb Oxygen Concentrator 5lit

- Self-Check Mode circuit with clear audiovisual indications of the problem on the digital display.
- Large compressor with a 30% larger cylinder capacity and the best quality Saint-Gobain piston rings.
- Optional flame trap, which prevents the spread of fire in case of smoking.
- Advanced Oxygen Purity System of the oxygen sensor A.O.S (Advance Oxygen Sensor).
- High-speed nebulization, at half the required time of a nebulizer, due to high flow rate.



Ideal choice for nursing homes & hospitals !

High-Speed Nebulizer Treatment due to High Air Flow Rate!

| | |
|------------------------|--|
| Power consumption (W) | 480 |
| Operating Power (V/Hz) | 230 ± 10% / 50 ± 1 |
| Flow Rate (l/min) | 1-5 |
| Concentration (%) | 93 ± 3 |
| Operating Air Flow | 18 l/min |
| Noise Level (dB) | ≤40 |
| Net Weight (Kg) | 24 Kg |
| Dimensions (mm) | 390x337x620 |
| Oxygen Alarm | Activated when the concentration purity of the oxygen delivered is less than 82% |
| Warranty | 2 years (IRENE Neb) |

ref. 0810360 **10 Lt FORCE Oxygen Concentrator**

New Product

Force

The new power in Oxygen Therapy. With features and materials signed by major manufacturers, like Thomas Motors, the Force 10Lt Oxygen Concentrator offers high yields and ultimate reliability to user's need.

New Generation

| | |
|----------------------------|--------------------|
| Power Consumption (W) | 635 |
| Power Supply Requirements | 220V±22V, 50HZ±1HZ |
| Flow Rate (L/min) | 0-10 |
| Oxygen purity at 5 (L/min) | 93±3% |
| Oxygen purity 8 (L/min) | 90±3% |
| Oxygen purity 10 (L/min) | 87±3% |
| Noise Level dB (A) | ≤55 |
| Net weight (kg) | 27kg |
| Dimensions (cm) | 38,1x34,7x68,9 |
| Warranty | 2 years |

Advanced oxygen sensor with absolute compatibility with the European standard for Oxygen Concentrators (≥82%) with 3 warning steps.

92%+ (HIGH) 84% (RICH) 82% (LOW)



Motors constructed by the reliable construction Group

THOMAS



ref. 0810301

Cabin Filter for Thorax

- Weekly cleaning and replacement every 90 days



ref. 0810369

Cabin Filter for O2 10Lt Force Concentrator

- Weekly cleaning and replacement every 90 days



ref. 0810302

Intake Filter for Thorax & Force

- Change per patient or every 2,000 hours



ref. 0810304

Thorax Humidifier Adapter



ref. 0808254

Filter for O2 IRENE Concentrator

- Weekly cleaning and replacement every 90 days



ref. 0808542

Intake Filter for IRENE Concentrator

- Change per patient or every 3,000 hours

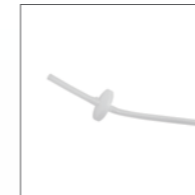

ref. 0808255

Antibacterial Filter for IRENE Concentrator with tube

- Change per patient or every 3,000 hours



ref. 0807319

Antibacterial Filter for IRENE Concentrator

- Change per patient or every 3,000 hours



ref. 0810331

Aura Cabin Filter

- Weekly cleaning and replacement every 60 days



ref. 0810332

Aura Intake Filter

- Replace every 30 days



ref. 0810343

External Battery charging Dock for Aura



ref. 0810342

Rechargeable Lithium Battery for Aura

To protect your health and the proper functioning of equipment, consult your dealer or the Instructions Manual for the intended filter change.

Oxygen Therapy Consumables

www.mobiaicare.gr



ref. 0217002

O2 Therapy Nasal Cannulas

2 meters
Packing 50 pcs.



ref. 0217005

Oxygen Mask for Adults

2 meters
Packing 50 pcs.



ref. 0217033

Oxygen Mask for Children

2 meters



ref. 0217011

Oxygen Tube

7.5 meters
Packing 25 pcs



ref. 0217009

Water trap

Packing 10 pcs.



ref. 0807645

Oxygen Tube Connector

Packing 25 pcs.



ref. 0808623

Flame Trap

The flame trap prevents the spread of fire in case of smoking (optional). (According to EN ISO 8359 EU Directive rev. 1/7/2012).



ref. 0810081

Salter Labs O2 Concentrator Humidifier Bottle

- Packing 50 pcs.
- Pressure tolerance up to 3 psi (0.4 bar)



ref. 0810646

10 Lit Salter O2 Concentrator Humidifier Bottle

- Packing 25 pcs.
- Pressure tolerance up to 9 psi (0.6 bar)
- 6-15 LPM



ref. 0806205

5-10lit O2 Concentrator Humidifier Bottle

- Pressure tolerance up to 14 psi (0.96 bar)

Nebulizer Treatment Consumables



ref. 0148006

High Flow Nebulizer Set Adult

- Approximately 50% faster nebulizer treatment compared to standard sets



ref. 0148007

High Flow Nebulizer Set Pediatric

- Approximately 50% faster nebulizer treatment compared to standard sets



ref. 0807283

Adult Nebulizer Treatment Set

- Packing 50 pcs.



ref. 0804005

Gem Nebulizer Spare Filter



ref. 0803014

Pediatric Nebulizer Treatment Set

- Packing 50 pcs.

To protect your health and the proper functioning of equipment, consult your dealer or the Instructions Manual for the intended filter change.

Nebulization

ref. 0806380

Nebulizer MOBIAC GEM

Warranty 5 years
Maximum air pressure 2,5 bar
Flow Rate 0,35 ml/min.
Dimensions: (LxWXH) 13x10x15cm

- Easy to use
- Fast nebulization, up to 50% of the time thanks to the high flow chamber
- Includes an adult and child mask, accessory for nasal use, high flow chamber and spare filter
- Packing: 1-6pcs/box L40xW21xH33 5Kg



ref. 0804005

GEM spare filter



Inhalation Chamber



ref. 0807335 **New Product**

Inhalation Chamber with S-size Mask

- Suitable for asthma treatment
- Inhaled medicines are delivered without any leakage



ref. 0807336 **New Product**

Inhalation Chamber with M-size Mask

- Suitable for asthma treatment
- Inhaled medicines are delivered with no drug loss



ref. 0807337 **New Product**

Inhalation Chamber with L-size Mask

- Suitable for asthma treatment
- Inhaled medicines are delivered with no drug loss

CONSUMABLES



ref. 0806355 **MC1-1 Oxygen Analyzer** **New Product**

The MC1-1 analyzer was designed to quickly verify oxygen concentration at a glance, including the flow and outlet pressure of oxygen concentrators. Its advanced design provides high-level performance and reliability.

The MC1-1 oxygen analyzer includes the following beneficial features:

- Oxygen-Flow Pressure Analyzer
- Portable, Fast & Reliable
- Oxygen Purity 20-96%
- Flow 0-10 l/min
- Pressure 0-3 bar
- 2 Years Warranty
- Pressure Option to kPa, BAR, PSI
- Calibration in Seconds with 2 clicks
- Carrying bag included



ref. 0807501 **Sterilizing respiratory device** **New Product**

TECHNICAL SPECIFICATION:

- Size: 117x68x50 (mm)
- Weight: 205 gr
- Power: 4w
- Storage temperature: -20°C ~ 55°C
- Operating temperature: 10°C ~ 45°C
- Degree of shielding: IPX1
- With built-in lithium battery, more environmentally friendly and easier to use.



The long-term use of your respiratory tract accumulates large amounts of bacteria at risk of contracting your respiratory tract.



Healthy Living



Front Side

Rear Side

ref. **0806401** CPAP Morfeus

Exclusive Series

- Treatment Recorded on Micro-SD card
- Alarm activated in case of power failure
- Alarm activation in case of air leakage
- Monitor Brightness Settings
- Auto-Start and Auto-Off functions
- Clock and Alarm Clock functions
- Ramp operation: 0 - 60min
- Convenient carrying and storage bag
- Built-in humidifier
- Greek-Language Software for Data Analysis and Printing
- Noise Level: 30 dBA
- Setting treatment parameters from PC using the MorfeusView Software
- Pressure Range: 4 - 20 cm H₂O
- 2-year warranty

ref. **0806402** CPAP Morfeus Soft

- Treatment Recorded on Micro-SD card
- Alarm activation in case of power failure
- Alarm activation in case of air leakage
- Monitor Brightness Settings
- Clock & Alarm Clock functions
- Auto-Start & Auto-Off functions
- Ramp operation: 0 - 60min
- Built-in humidifier
- Greek-Language Software for Data Analysis and Printing
- Convenient carrying and storage bag
- Three-level pressure reduction function at exhalation (EPS)
- Large 2.8" colour monitor
- Apnea Display on Monitor
- Mask Placement Function
- Service Reminder
- Possibility to record SpO₂ and pulse frequency (using optional sensor)
- Noise Level: 30 dBA
- Setting treatment parameters from PC using the MorfeusView Software
- Pressure Range: 4 - 20 cm H₂O
- 2-year warranty



Front Side

Rear Side



Oximeter (optional accessory)



Micro-SD card



Dust Filter



350ml Humidifier Bottle with an especially designed safety cap

ref. **0806403** CPAP Morfeus Auto (Auto-adjusting Pressure)

Exclusive Series

- Treatment Recorded on Micro-SD card
- Alarm activation in case of power failure
- Alarm activation in case of air leakage
- Monitor Brightness Settings
- Auto-Start & Auto-Off functions
- Clock & Alarm Clock functions
- Ramp operation: 0 - 60min
- Convenient carrying and storage bag
- Built-in humidifier
- Greek-Language Software for Data Analysis and Printing
- Noise Level: 30 dBA
- Three-level pressure reduction function at exhalation (EPS)
- Apnea Display on Monitor
- Mask Placement Function
- Setting treatment parameters from PC using the MorfeusView Software
- Pressure Range: 4 - 20 cm H₂O
- 2-year warranty



Front Side

Rear Side

ref. **0806404** CPAP Morfeus II Auto (Auto-adjusting Pressure)

Exclusive Series

- Treatment Recorded on Micro-SD card
- Alarm activation in case of power failure
- Alarm activation in case of air leakage
- Monitor Brightness Settings
- Auto-Start & Auto-Off functions
- Clock & Alarm Clock functions
- Ramp operation: 0 - 60min
- Convenient carrying and storage bag
- Built-in humidifier
- Greek-Language Software for Data Analysis and Printing
- Three-level pressure reduction function at exhalation (EPS)
- Large 2.8" colour monitor
- Apnea Display on Monitor
- Mask Placement Function
- Service Reminder
- Possibility to record SpO₂ and pulse frequency (using optional sensor)
- Noise Level: 30 dBA
- Inhalation/Exhalation Trigger
- Setting treatment parameters from PC using the MorfeusView Software
- Pressure Range: 4 - 20 cm H₂O
- 2-year warranty



Front Side

Rear Side



Oximeter (optional accessory)



Micro-SD card



Dust Filter



350ml Humidifier Bottle with an especially designed safety cap

ref. **0808397** BiLevel Ventus 20 S

Exclusive Series

Data Display on Monitor:

- EPAP: Expiratory positive airway pressure
- IPAP inhalation positive air pressure
- Vt: Tidal Volume
- Vleak: Leak Volume
- BR: Breathing Rate



- Large 2.8" colour monitor
- Display of treatment data numerically and in a pressure bar chart.
- Treatment Recorded on Micro-SD card
- Alarm activation in case of power failure
- Alarm activation in case of air leakage
- Alarm in case of Stop Breathing
- Convenient carrying and storage bag
- Ramp Operation: 0-45min
- Noise Level: 30 dBA
- Modes: CPAP, BiLevel S
- IPAP Range: 4-20cm H₂O
- EPAP Range: 4-20cm H₂O
- 2-year warranty



ref. **0806650** HYDOR Humidifier

- Heated Humidifier with 6 different settings
- Can be used with both Ventus S & Ventus S/T devices
- Recommended to prevent dryness in the throat area
- 1-year warranty

ref. **0808398** BiLevel Ventus 25-S/T

Exclusive Series

Data Display on Monitor:

- EPAP: Expiratory positive airway pressure
- IPAP inhalation positive air pressure
- Vt : Tidal Volume
- Vleak: Leak Volume
- BR: Breathing Rate
- I:E: Inhalation/Exhalation Ratio
- Time: Treatment Duration
- MVent: Minute Ventilation



- Large 2.8" colour monitor
- Display of treatment data numerically and in a pressure bar chart.
- Treatment Recorded on Micro-SD card
- Alarm activation in case of power failure
- Alarm activation in case of air leakage
- Alarm in case of Stop Breathing
- Convenient carrying and storage bag
- Ramp Operation: 0-45min
- Noise Level: 30 dBA
- Modes: CPAP, BiLevel S, BiLevel S/T
- IPAP Range: 4-25cm H₂O
- EPAP Range: 4-20cm H₂O
- 2-year warranty



ref. **0806650** HYDOR Humidifier

- Heated Humidifier with 6 different settings
- Can be used with both Ventus S & Ventus S/T devices
- Recommended to prevent dryness in the throat area
- 1-year warranty



ref. **0807914**

Filter for Morfeus Devices

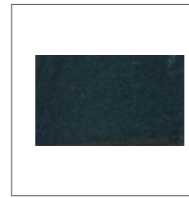

ref. **0806612**

Black Filter for Ventus Devices



ref. **0806611**

White Filter for Ventus Devices



ref. **0220030**

CPAP-BiLevel Universal Breathing Circuit



ref. **0810200**

Morfeus Oximeter Soft/Auto II
Suitable for CPAP Morfeus Soft / Auto II Devices



ref. **0808207**

Oxygen Enrichment Connector for CPAP Devices



ref. **0807223**

Disposable Antibacterial Filter

- Compatible with CPAP Morfeus & BiLevel Ventus Devices.
- For hygiene reasons, it should be used in case of device testing or use by a different user

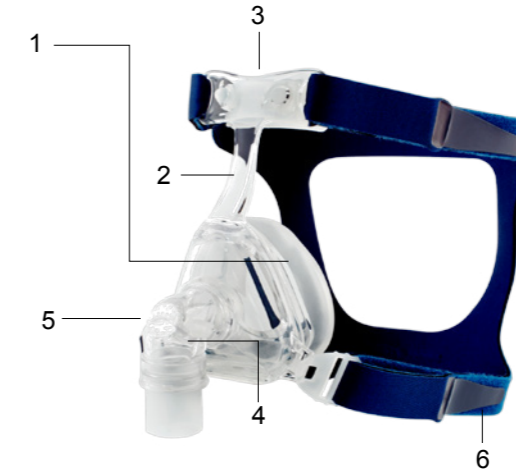

| | |
|---------------------|--|
| ref. 0806356 | CPAP nasal mask w/headgear, S size |
| ref. 0806357 | CPAP nasal mask w/headgear, M size |
| ref. 0806358 | CPAP nasal mask w/headgear, L size |
| ref. 0806359 | CPAP Full face mask w/headgear, S size |
| ref. 0806360 | CPAP Full face mask w/headgear, M size |
| ref. 0806361 | CPAP Full face mask w/headgear, L size |

1. Silicone Pillow

The soft silicone cushion offers maximum comfort. Easily applied to the skeleton of the mask. Available in 3 sizes (S, M, L).

2. Frame

Lightweight and durable, with easy pillow adjustment & better hygiene.

3. Front Pillow

Made of flexible silicone, it offers comfortable fit and absorbs pressure on the bridge of the nose.

4. Rotating Arm

The 360 ° swivel arm provides greater comfort for sleeping movements.

5. Silent

The special design for quiet exhalation ensures the patient a quiet sleep.

6. Head-hooks

Made of Velcro® material and easy-to-use hooks ensure the mask is correctly positioned.

To protect your health and the proper functioning of equipment, consult your dealer or the Instructions Manual for the intended filter change.

To protect your health and the proper functioning of equipment, consult your dealer or the Instructions Manual for the intended filter change.



ref. 0808061 **Suction Device (15lt/min) (220v)**

- Maximum Suction Pressure: -0.75 Bar
- Flow Rate: 15 lt / min at -0.75 Bar
- Noise level with container: 59,60 dBA
- Weight: 2.20 Kg
- Warranty 2 years



ref. 0808106 **Suction Device 30 (40Lt/min) (220v)**

- Maximum Suction Pressure: -0.80 Bar
- Flow Rate: 40 lt / min at -0.80 Bar
- Noise level with container: 60.5 dBA
- Weight: 3.60 Kg
- Warranty 2 years



ref. 0808086 **Suction Device 230/12V BR (16Lt/min) (220v / 12v)**

- Battery: Lead 12V-4A, Autonomy 80 minutes
- Low battery audio - visual notification
- Recharge time: 4 hours
- Car adapter included.
- Maximum Suction Pressure: -0.75 Bar
- Flow Rate: 16 lt / min at -0.75 Bar
- Noise level with container: 63 dBA
- Weight: 3.50 Kg
- Battery warranty 6 months
- Warranty 2 years



ref. 0808087 **Suction Device 36 BR Lead (36Lt/min) (220v / 12v)**

- Battery: Lead 12V-4A, 60 minutes autonomy
- Low battery visual - audio notification
- Recharge time: 4 hours
- Car adapter included.
- Maximum Suction Pressure: -0.80 Bar
- Flow Rate: 36 lt / min at -0.80 Bar
- Noise level with container: 65.5 dBA
- Weight: 4.39 Kg
- Battery warranty 6 months
- Warranty 2 years

ref. 0809543 (N° 12) Packing 60 pcs.

ref. 0809015 (N° 14) Packing 60 pcs.

ref. 0809682 (N° 16) Packing 60 pcs.

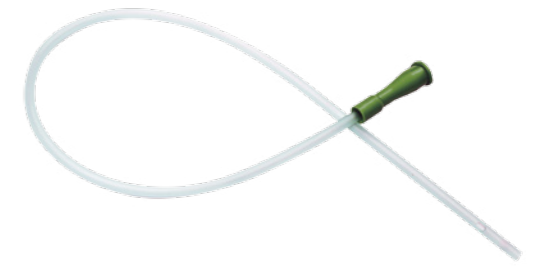

ref. 0809621 With Splitter (N° 12) Packing 60 pcs.

ref. 0809390 With Splitter (N° 14) Packing 60 pcs.

ref. 0806773 With Splitter (N° 16) Packing 60 pcs.

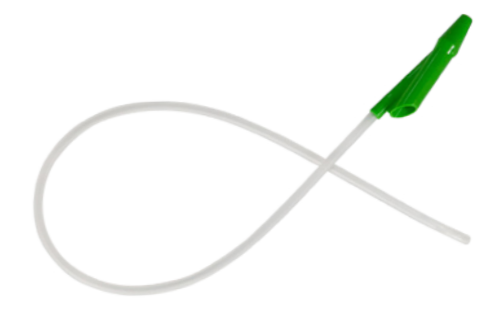

Aspiration Devices & Catheters



ref. 0806321
Suction Filter



ref. 0808104
Suction Catheter Connector



ref. 0808284
1 lit canister for suction units



ref. 0808105
Filters & tubing Set

ref. 0808707
Filters & tubing for Hospivac 350

ref. 0808708
Filters & tubing for Hospivac 400



ref. 0808101
2 lit canister for suction units Hospivac

Urine Collection Bags

ref. 0809012 **Bed Urine Collection Bag**

- 2lt Capacity
- 250 pcs./ box



ref. 0809544 **Bed T-Valve Urine Collection Bag**

- With drainage valve
- 2lt Capacity
- 250 pcs./ box



To protect your health and the proper functioning of equipment, consult your dealer or the Instructions Manual for the intended filter change.

To protect your health and the proper functioning of equipment, consult your dealer or the Instructions Manual for the intended filter change.



ref. **0801023** **MySPO2 Finger Oximeter**

- Automatic shut down after 5 sec when not in use.
- 2 cases included: A zipped storage case & a silicone-protective case.
- Display: Single-Colour LED
- Range of Oxygen Saturation Measurement: 35 - 100%
- Range of Heart Rate Measurement: 30 - 240 BPM
- Power Supply: 2 1.5 V (AAA size) alkaline batteries
- Display: SPO2, pulses
- 1-year warranty



ref. **0807862** **Oximeter Silicone Case**

- For Oximeter 0801023



ref. **0801024** **SenseO2 Finger Oximeter** **New Product**

SENSE²

- Small in volume, light weight and comfortable to carry.
- Simple operation of the product with low power consumption (Less than 30mA).
- SpO2 value indication (0% to 100%).
- Rhythm pulse display via bar display (30 bpm to 250 bpm).
- Pulse waveform indicator
- Variable imaging mode (6 different value configurations).
- Variable screen brightness (5 levels).
- Low voltage indication: Low voltage indication prior to abnormal operation, which is due to low voltage.
- Auto Power Off: Automatic Deactivation within 5 seconds if the finger drops out the sensor
- The display layout is saved after deactivation.
- Modern, elegant design.
- Operation with 2 AAA batteries for up to 32 consecutive hours.
- 1-year warranty.



ref. **0808362** **MySPO2 Watch Wrist Oximeter with Recorder**

- Alarm: Audiovisual Indications with Adjustable Levels (high - low).
- Connection to PC through USB drive for data analysis and printout using a Software (included).
- 20-hour recording capability for data management during sleep disturbance and nocturnal oximetry diagnosis
- Change direction to display.
- Package also includes two neonatal-pediatric adhesive sensors.
- Display: Colour OLED
- Range of Oxygen Saturation Measurement: 0 - 100%
- Range of Heart Rate Measurement: 30 - 240 BPM
- Power Supply: Charging via a USB adapter, or a USB port of a PC
- Display: Bar Chart and Wave form, Alarms, Battery Condition, PI, SPO2 Alarm low limit
- 1-year warranty



Diagnostic Devices

ref. **0808533** **Neonatal Sensor**

- Neonatal Adhesive Sensor for cod. 0808362



ref. **0808413** **Adult Sensor**

- Adult Fingertip Sensor for cod. 0808362





ref. **0808383** **Wheelchair Basic I**

ref. **0808483** **WheelChair Basic II**

| | |
|-----------|---|
| FRAME | Steel |
| COLOUR | Forged charcoal or Black (depending on availability)* |
| SEAT | Fabric |
| ARMRESTS | Fixed |
| FOOTRESTS | Fixed |
| WHEELS | Solid radial wheels |



ref. **0223016** **Wheelchair Profit I**

| | |
|-----------|---|
| FRAME | Steel |
| COLOUR | Forged charcoal or Black (depending on availability)* |
| SEAT | Fabric |
| ARMRESTS | Detachable |
| FOOTRESTS | Detachable |
| WHEELS | Pneumatic radial tires |
| BRAKES | On the handles |



ref. **0813016** **Wheelchair Profit I SOLID**

| | |
|-----------|---|
| FRAME | Steel |
| COLOUR | Forged charcoal or Black (depending on availability)* |
| SEAT | Fabric |
| ARMRESTS | Detachable |
| FOOTRESTS | Detachable |
| WHEELS | Solid radial wheels |

| 0808383 | 46cm | 49cm | 41cm | 45cm | 67cm | 106cm | 87cm | 49cm | 24"8" | 100kg | 17kg | |
|----------------|------|------|------|------|------|-------|------|------|-------|-------|------|--|
| 0808483 | 41cm | 44cm | 41cm | 40cm | 62cm | 106cm | 87cm | 49cm | 24"8" | 100kg | 17kg | |
| 0223016 | 46cm | 45cm | 41cm | 41cm | 65cm | 108cm | 90cm | 49cm | 24"8" | 100kg | 19kg | |
| 0813016 | 46cm | 45cm | 40cm | 40cm | 65cm | 108cm | 90cm | 49cm | 24"8" | 100kg | 19kg | |

*Regarding the arrival of the black colour, you will be informed via email sent by the Sales Department
The above wheelchairs with detachable footrests can be equipped with reclining footrests upon additional charge

ref. **0806059** **Wheelchair Profit IV**

| | |
|-----------|---|
| FRAME | Steel |
| COLOUR | Forged charcoal or Black (depending on availability)* |
| SEAT | Leather |
| ARMRESTS | Folding |
| FOOTRESTS | Detachable |
| WHEELS | Pneumatic radial tires |
| BRAKES | On the handles |



Wheelchairs

| 0806059 | 46cm | 45cm | 41cm | 41cm | 65cm | 108cm | 90cm | 50cm | 24"8" | 100kg | 19kg | |
|----------------|------|------|------|------|------|-------|------|------|-------|-------|------|--|

*Regarding the arrival of the black colour, you will be informed via email sent by the Sales Department
** New wheel is being expected. You will be informed via email sent by the Sales Department
The above wheelchairs with detachable footrests can be equipped with reclining footrests upon additional charge



ref. **0810802** Wheelchair Aluminium Premium FIX **New Product**

| | |
|-----------|---------------------------------------|
| FRAME | Aluminium |
| COLOUR | Silver |
| SEAT | Reinforced fabric, breathable cushion |
| ARMRESTS | Folding |
| FOOTRESTS | Fixed |
| WHEELS | Solid radial wheels, Quick Release |
| BRAKES | On the handles |

ADDITIONAL FEATURES

| |
|--|
| Tilting backrest |
| Height-adjustable, anti-tipping supporting casters |
| Double-cross support bar under the seat |
| Wheelchair weight without rear wheels 11.60 Kg |



0810802 & 0810803



ref. **0810803** Wheelchair Aluminium Executive FIX **New Product**

| | |
|-----------|---------------------------------------|
| FRAME | Aluminium |
| COLOUR | Silver |
| SEAT | Reinforced fabric, breathable cushion |
| ARMRESTS | Folding |
| FOOTRESTS | Detachable |
| WHEELS | Solid radial wheels, Quick Release |

ADDITIONAL FEATURES

| |
|--|
| Tilting backrest |
| Height-adjustable, anti-tipping supporting casters |
| Double-cross support bar under the seat |
| Wheelchair weight without rear wheels, 12.60 Kg |
| Center of gravity can be adjusted in relation to rear wheels |



| 0810802 | 46cm | 46cm | 44cm | 39cm | 66cm | 104cm | 92cm | 52cm | 24"8" | 110kg | 15kg |
|----------------|------|------|------|------|------|-------|------|------|-------|-------|------|
| 0810803 | 46cm | 46cm | 45cm | 36cm | 69cm | 106cm | 90cm | 54cm | 24"8" | 110kg | 16kg |



ref. **0808480** Wheelchair Golden (red - black)

| | |
|-----------|---|
| FRAME | Steel |
| COLOUR | Forged charcoal or Black (depending on availability)* |
| SEAT | Fabric with reinforced red-black cushion |
| ARMRESTS | Folding |
| FOOTRESTS | Detachable |
| WHEELS | Solid |
| BRAKES | On the handles |



Wheelchairs



ref. **0808481** Wheelchair Golden (blue - black)

| | |
|-----------|---|
| FRAME | Steel |
| COLOUR | Forged charcoal or Black (depending on availability)* |
| SEAT | Fabric with reinforced blue-black cushion |
| ARMRESTS | Folding |
| FOOTRESTS | Detachable |
| WHEELS | Solid |
| BRAKES | On the handles |



| 0808480 | 46cm | 43cm | 45cm | 41cm | 67cm | 106cm | 88cm | 49cm | 24"8" | 100kg | 19kg |
|----------------|------|------|------|------|------|-------|------|------|-------|-------|------|
| 0808481 | 46cm | 43cm | 45cm | 41cm | 67cm | 106cm | 88cm | 49cm | 24"8" | 100kg | 19kg |

*Regarding the arrival of the black colour, you will be informed via email sent by the Sales Department
The above wheelchairs with detachable footrests can be equipped with reclining footrests upon additional charge



120kg ref. **0811300** Wheelchair Gemini 24' 46cm **New Product**

120kg ref. **0811301** Wheelchair Gemini 24' 43cm **New Product**

| | |
|-----------|------------|
| FRAME | Steel |
| COLOUR | Silver |
| SEAT | Fabric |
| ARMRESTS | Folding |
| FOOTRESTS | Detachable |
| WHEELS | Solid |

| ADDITIONAL FEATURES | |
|---|--|
| Double-cross support bar under the seat | |

With reinforced wheels 200x50cm



120kg ref. **0811302** Wheelchair Gemini 12' 46cm **New Product**

120kg ref. **0811303** Wheelchair Gemini 12' 43cm **New Product**

| | |
|-----------|------------|
| FRAME | Steel |
| COLOUR | Silver |
| SEAT | Fabric |
| ARMRESTS | Folding |
| FOOTRESTS | Detachable |
| WHEELS | Solid |

| ADDITIONAL FEATURES | |
|---|--|
| Double-cross support bar under the seat | |

With reinforced wheels 200x50cm

| 0811300 | 47cm | 46cm | 40cm | 42cm | 62cm | 79cm | 93,5cm | 50,5cm | 24"8" | 120kg | 18kg |
|----------------|------|------|------|------|------|------|--------|--------|-------|-------|------|
| 0811301 | 44cm | 43cm | 40cm | 42cm | 56cm | 79cm | 93,5cm | 50,5cm | 24"8" | 120kg | 18kg |
| 0811302 | 47cm | 46cm | 40cm | 42cm | 62cm | 79cm | 93,5cm | 50,5cm | 12"8" | 120kg | 18kg |
| 0811303 | 44cm | 43cm | 40cm | 42cm | 56cm | 79cm | 93,5cm | 50,5cm | 12"8" | 120kg | 18kg |

182kg ref. **0808527** Heavy Duty Wheelchair

| | |
|-----------|-------------|
| FRAME | Steel |
| COLOUR | Red - Black |
| SEAT | Fabric |
| ARMRESTS | Folding |
| FOOTRESTS | Detachable |
| WHEELS | Solid |

| ADDITIONAL FEATURES | |
|---|--|
| Double-cross support bar under the seat | |



With reinforced wheels 200x50cm

| 0808527 | 56cm | 57cm | 46cm | 44cm | 76cm | 88cm | 95cm | 50cm | 24"8" | 182kg | 21kg |
|----------------|------|------|------|------|------|------|------|------|-------|-------|------|

*Regarding the arrival of the black colour, you will be informed via email sent by the Sales Department
The above wheelchairs with detachable footrests can be equipped with reclining footrests upon additional charge



ref. **0808505**

Cerebral Palsy Wheelchair Aluminium



ref. **0808612**

Cerebral Palsy Wheelchair Aluminium



| | |
|-----------|----------------------|
| FRAME | Aluminium |
| COLOUR | Blue |
| SEAT | Reinforced Fabric |
| ARMRESTS | Folding |
| FOOTRESTS | Detachable & Lifting |
| WHEELS | Solid 16" |

| ADDITIONAL FEATURES | |
|--------------------------------|--|
| 45° reclining seat, adjustable | |
| 90° to 165° reclining backrest | |
| Crossed safety belt | |
| Anti-tipping casters | |



| 0808505 | 36cm | 32cm | 36cm | 40cm | 51cm | 104cm | 95cm | 52cm | 16"8" | 75kg | 23kg |
|----------------|------|------|------|------|------|-------|------|------|-------|------|------|
| 0808612 | 46cm | 42cm | 40cm | 49cm | 61cm | 108cm | 95cm | 52cm | 16"8" | 75kg | 23kg |



ref. **0808837**

Wheelchair Reclining

| | |
|-----------|-------------------------------------|
| FRAME | Steel |
| COLOUR | Charcoal |
| SEAT | Comfortable with adjustable cushion |
| ARMRESTS | Detachable |
| FOOTRESTS | Detachable & Lifting |
| WHEELS | Solid 16" |
| BRAKES | On the handles |

| ADDITIONAL FEATURES | |
|--------------------------|--|
| Fully reclining backrest | |
| Anti-tipping casters | |



With middle rear wheels

With reinforced wheels 200x50cm



ref. **0808838**

Wheelchair Reclining

| | |
|-----------|-------------------------------------|
| FRAME | Steel |
| COLOUR | Charcoal |
| SEAT | Comfortable with adjustable cushion |
| ARMRESTS | Detachable |
| FOOTRESTS | Detachable & Lifting |
| WHEELS | Solid |
| BRAKES | On the handles |

| ADDITIONAL FEATURES | |
|--------------------------|--|
| Fully reclining backrest | |
| Anti-tipping casters | |



With large pneumatic rear tires

With reinforced wheels 200x50cm

| 0808837 | 45cm | 48cm | 41cm | 54cm | 59cm | 112cm | 120cm | 58cm | 12"8" | 150kg | 35,5kg |
|----------------|------|------|------|------|------|-------|-------|------|-------|-------|--------|
| 0808838 | 45cm | 48cm | 43cm | 54cm | 68cm | 125cm | 120cm | 58cm | 24"8" | 150kg | 37,5kg |

Wheelchairs



ref. **0809236**

Wheelchair Reclining

| | |
|-----------|---|
| FRAME | Steel |
| COLOUR | Forged charcoal or Black (depending on availability)* |
| SEAT | Leather |
| ARMRESTS | Detachable |
| FOOTRESTS | Detachable & Lifting |
| WHEELS | Solid |
| BRAKES | On the handles |

ADDITIONAL FEATURES

| |
|--------------------------------|
| 90° to 180° reclining backrest |
| Detachable head support |
| Anti-tipping casters |

****Upgrade with front wheel for 200x50cm.**
New wheel is being expected.
You will be informed via email sent by the Sales Department.



With reinforced wheels**

| | | | | | | | | | | | |
|------|------|------|------|------|-------|-------|------|-------|-------|------|--|
| | | | | | | | | | | | |
| 46cm | 45cm | 41cm | 82cm | 65cm | 118cm | 132cm | 51cm | 24"8" | 100kg | 26kg | |

*Regarding the arrival of the black colour, you will be informed via email sent by the Sales Department
** New wheel is being expected. You will be informed via email sent by the Sales Department



ref. **0806062**

Wheelchair Reclining with commode

| | |
|-----------|---|
| FRAME | Steel |
| COLOUR | Forged charcoal or Black (depending on availability)* |
| SEAT | Leather seat with commode |
| ARMRESTS | Detachable |
| FOOTRESTS | Detachable & Lifting |
| WHEELS | Solid |
| BRAKES | On the handles |

ADDITIONAL FEATURES

| |
|---|
| Sliding seat for easy use, with commode |
| 90° to 180° reclining backrest |
| Detachable head support |
| Anti-tipping casters |

****Upgrade with front wheel for 200x50cm.**
New wheel is being expected.
You will be informed via email sent by the Sales Department



With reinforced wheels**



Sliding seat with commode

Wheelchairs

| | | | | | | | | | | | |
|------|------|------|------|------|-------|-------|------|-------|-------|------|--|
| | | | | | | | | | | | |
| 46cm | 44cm | 45cm | 74cm | 69cm | 122cm | 122cm | 55cm | 24"8" | 100kg | 28kg | |

*Regarding the arrival of the black colour, you will be informed via email sent by the Sales Department
** New wheel is being expected. You will be informed via email sent by the Sales Department

 ref. **0808377** Wheelchair Folding Aluminium

| | |
|-----------|----------------|
| FRAME | Aluminium |
| COLOUR | Blue |
| SEAT | Fabric |
| ARMRESTS | Folding |
| FOOTRESTS | Folding |
| WHEELS | Solid 8" |
| BRAKES | On the handles |

| ADDITIONAL FEATURES | |
|--|--|
| With safety belt | |
| Fully folding frame | |
| Convenient carrying bag | |
| Paint based on nanotechnology, which makes it more resistant | |



 ref. **0810170** Wheelchair Basic IV

| | |
|-----------|---|
| FRAME | Steel |
| COLOUR | Forged charcoal or Black (depending on availability)* |
| SEAT | Leather |
| ARMRESTS | Fixed |
| FOOTRESTS | Fixed |
| WHEELS | Solid |

| ADDITIONAL FEATURES | |
|---------------------|--|
| With safety belt | |















Wheelchairs













 ref. **0806778** Indoor Wheelchair I

| | |
|-----------|---|
| FRAME | Steel |
| COLOUR | Forged charcoal or Black (depending on availability)* |
| SEAT | Leather |
| ARMRESTS | Folding |
| FOOTRESTS | Detachable |
| WHEELS | Solid |

| ADDITIONAL FEATURES | |
|---------------------|--|
| With safety belt | |



| | | | | | | | | | | | | |
|----------------|---|---|---|---|---|---|---|---|--|---|---|---|
| |  |  |  |  |  |  |  |  |  |  |  |  |
| 0808377 | 41cm | 41cm | 36cm | 40cm | 48cm | 98cm | 88cm | 47cm | 8" 5" | 75kg | 9kg | |

| | | | | | | | | | | | | |
|----------------|---|---|---|---|---|---|---|---|---|---|---|---|
| |  |  |  |  |  |  |  |  |  |  |  |  |
| 0810170 | 46cm | 51cm | 41cm | 42cm | 64cm | 92cm | 89cm | 49cm | 12"8" | 100kg | 16kg | |
| 0806778 | 46cm | 45cm | 40cm | 42cm | 64cm | 100cm | 90cm | 51cm | 12"8" | 100kg | 16kg | |

*Regarding the arrival of the black colour, you will be informed via email sent by the Sales Department

*Regarding the arrival of the black colour, you will be informed via email sent by the Sales Department
On 806778 & 0809639 models with detachable footrests, reclining footrests can be placed upon additional charge



ref. **0808367**

Wheelchair with Commode III

| | |
|-----------|---|
| FRAME | Steel |
| COLOUR | Nickel |
| SEAT | U-type leather seat with square commode |
| ARMRESTS | Folding |
| FOOTRESTS | Detachable & Lifting |
| WHEELS | Solid radial wheels |
| BRAKES | On the handles |

ADDITIONAL FEATURES

Double-cross support bar under the seat



With reinforced wheels
200x38cm



ref. **0223004**

Wheelchair with Commode I

| | |
|-----------|---|
| FRAME | Steel |
| COLOUR | Forged charcoal or Black (depending on availability)* |
| SEAT | U-type leather seat with square commode |
| FOOTRESTS | Folding |
| WHEELS | Detachable |
| BRAKES | Pneumatic radial tires |



Wheelchairs

| | | | | | | | | | | | |
|----------------|------|------|------|------|------|-------|------|------|-------|-------|------|
| | | | | | | | | | | | |
| 0808367 | 51cm | 49cm | 44cm | 37cm | 70cm | 111cm | 88cm | 54cm | 24"8" | 120kg | 25kg |

| | | | | | | | | | | | |
|----------------|------|------|------|------|------|-------|------|------|-------|-------|------|
| | | | | | | | | | | | |
| 0223004 | 46cm | 44cm | 44cm | 37cm | 65cm | 106cm | 90cm | 55cm | 24"8" | 100kg | 21kg |

*Regarding the arrival of the black colour, you will be informed via email sent by the Sales Department
 ** New wheel is being expected. You will be informed via email sent by the Sales Department
 The above wheelchairs with detachable footrests can be equipped with reclining footrests upon additional charge

*Regarding the arrival of the black colour, you will be informed via email sent by the Sales Department
 The above wheelchairs with detachable footrests can be equipped with reclining footrests upon additional charge



 ref. **0807985** Indoor Wheelchair - III

| | |
|-----------|---|
| FRAME | Steel |
| COLOUR | Forged charcoal or Black (depending on availability)* |
| SEAT | U-type leather seat with square commode |
| ARMRESTS | Folding |
| FOOTRESTS | Detachable |
| WHEELS | Solid |
| BRAKES | On the handles |

| ADDITIONAL FEATURES | |
|---------------------|--|
| With safety belt | |



With reinforced wheels**

 ref. **0808489** Indoor Wheelchair - V

| | |
|-----------|---|
| FRAME | Steel |
| COLOUR | Nickel |
| SEAT | U-type leather seat with square commode |
| ARMRESTS | Folding |
| FOOTRESTS | Detachable |
| WHEELS | Solid |
| BRAKES | On the handles |

| ADDITIONAL FEATURES | |
|---------------------|--|
| With safety belt | |

****Upgrade with front wheel for 200x50cm.**
New wheel is being expected.
You will be informed via email sent by the Sales Department.

 ref. **0810120** Wheelchair Red

| | |
|-----------|---------------------------------|
| FRAME | Steel |
| COLOUR | NANO Red |
| SEAT | Leather seat with round commode |
| ARMRESTS | Folding |
| FOOTRESTS | Detachable |
| WHEELS | Solid 5" |
| BRAKES | On the rear wheels |



Paint based on nanotechnology, for additional resistance



























Wheelchairs

 ref. **0806053** Wheelchair

| | |
|-----------|---|
| FRAME | Steel |
| COLOUR | Forged charcoal or Black (depending on availability)* |
| SEAT | Leather seat with round commode |
| ARMRESTS | Folding |
| FOOTRESTS | Detachable |
| WHEELS | Solid 5" |
| BRAKES | On the rear wheels |



| |  |  |  |  |  |  |  |  |  |  |  |  |
|----------------|---|---|---|---|---|---|---|---|--|---|---|---|
| 0807985 | 46cm | 44cm | 45cm | 37cm | 64cm | 98cm | 90cm | 56cm | 12"8" | 100kg | 21kg | |
| 0808489 | 51cm | 49cm | 44cm | 37cm | 69cm | 98cm | 90cm | 54cm | 12"8" | 120kg | 21kg | |

| |  |  |  |  |  |  |  |  |  |  |  |  |
|----------------|---|---|---|---|---|---|---|---|---|---|---|---|
| 0810120 | 45cm | 43cm | 43cm | 44cm | 54cm | 91cm | 94cm | 52cm | 5" 5" | 100kg | 14kg | |
| 0806053 | 45cm | 43cm | 43cm | 44cm | 54cm | 91cm | 94cm | 52cm | 5" 5" | 100kg | 14kg | |

*Regarding the arrival of the black colour, you will be informed via email sent by the Sales Department
The above wheelchairs with detachable footrests can be equipped with reclining footrests upon additional charge

*Regarding the arrival of the black colour, you will be informed via email sent by the Sales Department



Paint based on nanotechnology, for additional resistance

100kg ref. **0808378** Wheelchair Shower

| | |
|-----------|---|
| FRAME | Aluminium |
| COLOUR | NANO Blue |
| SEAT | U-type leather seat with square commode |
| ARMRESTS | Fixed |
| FOOTRESTS | Built-in Mechanism |
| WHEELS | Solid 5" |
| BRAKES | On the rear wheels |

ADDITIONAL FEATURES
Special waterproof coating



With detachable footrests

100kg ref. **0806777** Simple Wheelchair

| | |
|-----------|---|
| FRAME | Steel |
| COLOUR | Nickel |
| SEAT | U-type leather seat with square commode |
| ARMRESTS | Folding |
| FOOTRESTS | Detachable |
| WHEELS | Solid 5" |
| BRAKES | On the rear wheels |



With detachable footrests

100kg ref. **0808396** Simple Wheelchair-Folding

| | |
|-----------|---|
| FRAME | Steel |
| COLOUR | Nickel |
| SEAT | U-type leather seat with square commode |
| ARMRESTS | Folding |
| FOOTRESTS | Detachable |
| WHEELS | Solid 5" |
| BRAKES | On the rear wheels |



| | | | | | | | | | | | |
|----------------|------|------|------|------|------|------|-------|------|-------|-------|------|
| | | | | | | | | | | | |
| 0808378 | 43cm | 43cm | 44cm | 34cm | 53cm | 81cm | 103cm | 56cm | 5" 5" | 100kg | 9kg |
| 0806777 | 45cm | 44cm | 44cm | 47cm | 54cm | 91cm | 95cm | 49cm | 5" 5" | 100kg | 13kg |
| 0808396 | 45cm | 44cm | 44cm | 47cm | 54cm | 91cm | 95cm | 49cm | 5" 5" | 100kg | 13kg |

New New Product New Product

136kg ref. **0811304** Toilet-Shower Wheelchair Aqua

| | |
|-----------|-----------------------|
| FRAME | Aluminium |
| COLOUR | White |
| SEAT | PU |
| ARMRESTS | Folding |
| FOOTRESTS | Detachable |
| WHEELS | Solid - Quick Release |
| BRAKES | On the handles |

ADDITIONAL FEATURES
6 Wheels, 4x6" & 2 Wheels 24"
Waterproof
Pre-assembled

6 Wheels included



| | | | | | | | | | | | |
|--------------------|------|------|------|------|------|------|--------|------|-------|-------|------|
| | | | | | | | | | | | |
| 0811304 6" | 46cm | 45cm | 42cm | 37cm | 46cm | 61cm | 91cm | 51cm | 6" 6" | 136kg | 14kg |
| 0811304 24" | 46cm | 45cm | 42cm | 37cm | 60cm | 80cm | 91,5cm | 51cm | 24"6" | 136kg | 17kg |



ref. 0808695

Reinforced cushion Blue with scratch tape

Spare part cushion set N°46
(For wheelchairs with code 0808480, 0808481, 0808482)



ref. 0808382

Cushion with Straps

- Suitable for any wheelchair type with seat N°46
- Secured with the fitted straps



ref. 0808696

Reinforced cushion Red with scratch tape

Spare part cushion N°46
(For wheelchairs with code 0808480, 0808481, 0808482)



ref. 0807945

Cushion with cratch tape

Spare part cushion N°51
(For wheelchairs with code 0809241, 0806105)



ref. 0808697

Cushion Reinforced Orange with scratch tape

Spare part cushion N°46
(For wheelchairs with code 0808480, 0808481, 0808482)



ref. 0807620

Cushion with scratch tape

Spare part cushion N°46
(For wheelchairs with code 0808361, 0808715)

Small groove

Large groove

300kg

ref. 0808161

Folding Ramp

Dimensions (L): 77 to 210cm
Aluminium
Groove Dimensions (W):
Small: 11cm
Large: 12.8cm

227kg

ref. 0808515

Rolling Ramp

- Aluminium
- Can be folded and rolled
- Dimensions (LxW): 92 x 76 cm
- Special storage and carrying case



ref. 0808297

Wheelchair I.V Stand
Mounting base included

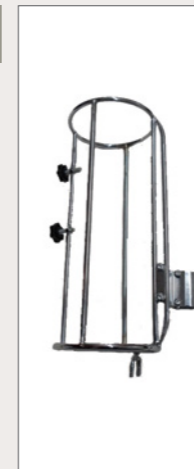

ref. 0808516

Wheelchair Oxygen Cylinder Holder
Suitable for 2lit & 3 lit Oxygen Cylinders

Wheelchairs codes for the following fitted IV Stand code (0808297) and Mounting Base (0808516)

| | |
|---------|---------------------------------------|
| 0808383 | Wheelchair Simple |
| 0808483 | Wheelchair Simple N°41 |
| 0223016 | Wheelchair Profit Fabric |
| 0813016 | Wheelchair Profit Leather + rim |
| 0808365 | Wheelchair Profit SOLID Wheel N°41 |
| 0806059 | Wheelchair Profit |
| 0809241 | Wheelchair STANDARD + rim |
| 0808482 | Wheelchair N°46 Orange/ Black Cushion |
| 0808487 | Wheelchair Simple + Commode N°46 |
| 0223004 | Wheelchair with Commode |

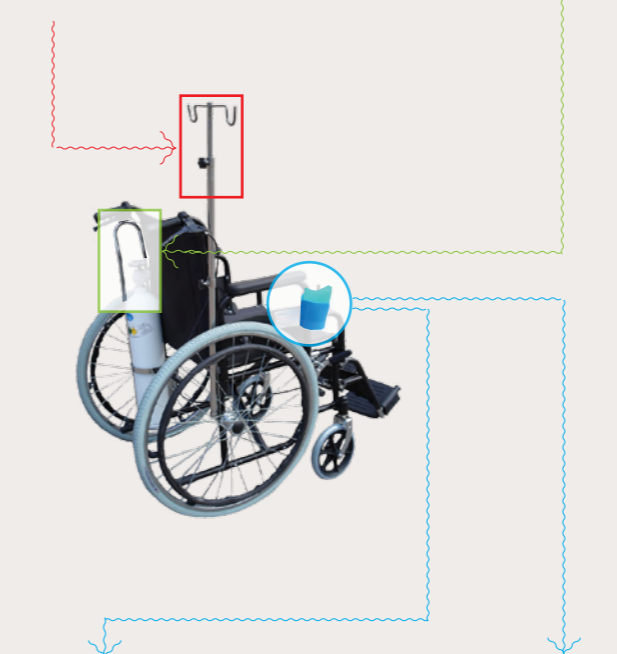

Wheelchair codes for fitted I.V Stand (0808297)

| | |
|---------|---|
| 0809239 | Wheelchair Profit + rim Upgraded with 200x38mm Front Wheel |
| 0810803 | Wheelchair Aluminium ALU III QR "Executive" |
| 0810170 | Indoor Wheelchair BASIC |
| 0806778 | Wheelchair Indoor |
| 0809639 | Indoor Wheelchair DELUXE N°46 |
| 0809348 | Wheelchair with Commode + rim |
| 0808367 | Wheelchair with commode Lifting Footrests (51cm) |
| 0807985 | Indoor Wheelchair with commode |
| 0808488 | Indoor Wheelchair + Round Commode N°46 |
| 0808489 | Indoor Wheelchair, Reinforced + Commode N°51 |



ref. 0808519

Cup Holder for wheelchairs

Can be fixed on wheelchair arms

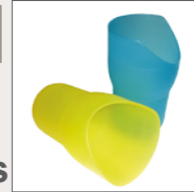

ref. 0808518

Cup for wheelchair (0808519)



ref. 0808716

Patient Transfer Board

- Folding plastic board
- Dimensions (LxW): 63.5 x 34.5cm
- Storage Dimensions (LxW): 63.5 x 12cm
- Smooth, non-slip surface.
- Maximum patient weight 100kg for a 20-cm maximum distance from the transfer point

ref. 0809340

Plastic Table

- Equipped with mounting base
- Suitable for any wheelchair type with seat N°46
- Dimensions (LxW): 54 x 31cm



The adjustable belt and mounting brackets allow quick and correct positioning of any body size to all wheelchair models, standard chairs or high chairs, and quick release in an emergency.



ref. **0808364** Wheelchair seat belt with clips

- Length (A): 80-140 cm (clips not included)
- Width (B): 3.7cm
- Suitable for all wheelchair types
- Secured around the seat or the backrest

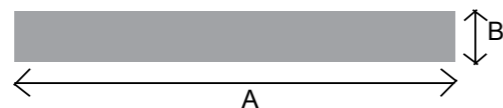

ref. **0809750** Wheelchairs crewed seat belt

- (Adjustable length) A: 40-55cm
 (Fixed length) B: 34cm
 (Width) C: 3,5cm
- Suitable for all wheelchair types
 - Secured by screwing it on the seat or the backrest (cod. 0809750)



ref. **0808676** Reinforced Belt

- Length (A): 30-55cm
- Length (B): 35cm
- Width (C): 4.5cm
- With safety lock



ref. **0808869** Cross-type Belt

- Suitable for all wheelchair types
- Secured around the seat or the backrest



ref. **0810800**

Power Wheelchair Convert

New Product

| | |
|-----------|---|
| FRAME | Aluminium |
| COLOUR | Blue |
| SEAT | Fabric with reinforced blue-black cushion |
| ARMRESTS | Fixed |
| FOOTRESTS | Detachable |
| WHEELS | Solid 20" |
| SPEED | 0.5 - 6km/h |
| AYTONOMY | 20km/h |
| INCLINE | up to 10° |
| MOTOR | 2 x 120W / 24V |
| BATTERY | 2 x 12V / month warranty |

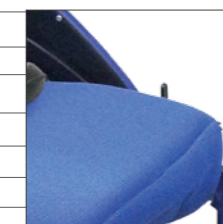

ADDITIONAL FEATURES

| |
|-----------------------------|
| Tilting backrest, One-piece |
| 2 motors and 2 batteries |
| Safety belt |
| Manual Operation |
| Anti-tipping casters |

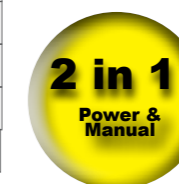

Power Wheelchairs Shoprider Scooters

With reinforced wheels 200x50cm



ref. **0808714**

Power Wheelchair - Venere

| | |
|-----------|---|
| FRAME | Aluminium |
| COLOUR | Blue |
| SEAT | Fabric with reinforced blue-black cushion |
| ARMRESTS | Folding |
| FOOTRESTS | Detachable |
| WHEELS | Solid |
| SPEED | 0,5 to 7km/h |
| AYTONOMY | 20km/h |
| INCLINE | up to 10° |
| MOTOR | 2 x 200W / 24V |
| BATTERY | 2 x 12V / 6 months warranty |

ADDITIONAL FEATURES

| |
|-----------------------------|
| Tilting backrest, One-piece |
| 2 motors and 2 batteries |
| Anti-tipping casters |



With reinforced wheels 200x50cm

| 0810800 | 46cm | 45cm | 42cm | 43cm | 68cm | 107cm | 91cm | 51cm | 20"8" | 100kg | 25kg | |
|----------------|------|------|------|------|------|-------|------|------|-------|-------|------|--|
| 0808714 | 46cm | 45cm | 42cm | 42cm | 63cm | 99cm | 90cm | 51cm | 12"8" | 110kg | 32kg | |

New NewProduct **New Product**



ref. **0811305**

Power Wheelchair
Phidias

| | |
|-----------|--------------------------------|
| FRAME | Steel |
| COLOUR | Black - Blue |
| SEAT | Fabric with reinforced cushion |
| ARMRESTS | Folding |
| FOOTRESTS | Detachable |
| WHEELS | Pneumatic |
| SPEED | max speed 10km/h |
| AYTONOMY | 20km/h |
| INCLINE | 10° |
| MOTOR | 2x200W/24V |
| BATTERY | 2 x 12V / 6 months warranty |

ADDITIONAL FEATURES

- Dynamic Controller
- Tilting backrest



With reinforced wheels
200x50cm



| | | | | | | | | | | | |
|------|------|------|------|------|-------|------|------|-------|-------|------|--|
| | | | | | | | | | | | |
| 47cm | 46cm | 43cm | 46cm | 69cm | 109cm | 95cm | 51cm | 12"8" | 120kg | 45kg | |



ref. **0809242**

Wheelchair
Reclining Comfort

| | |
|-----------|-----------------------------|
| FRAME | Black or Blue |
| COLOUR | Black - Beige |
| SEAT | Car-type |
| ARMRESTS | Folding |
| FOOTRESTS | Detachable & Lifting |
| WHEELS | Solid 12" |
| SPEED | 0,5 to 6km/h |
| AYTONOMY | 20km/h |
| INCLINE | up to 10° |
| MOTOR | 2 x 200W / 24V |
| BATTERY | 2 x 12V / 6 months warranty |

ADDITIONAL FEATURES

- Adjustable backrest with head restraint
- 2 motors and 2 batteries
- Anti-tipping casters



Autonomy up to 20Km!

With reinforced wheels
200x50cm

Power Wheelchairs
Shopper Scooters



| | | | | | | | | | | |
|------|------|------|------|------|-------|-------|------|-------|-------|------|
| | | | | | | | | | | |
| 47cm | 46cm | 41cm | 56cm | 65cm | 124cm | 124cm | 50cm | 12"8" | 120kg | 53kg |



With reinforced wheels 200x50cm

 100kg ref. **0806139** Wheelchair Stand-Up Cronus

| | |
|----------|-----------------------------------|
| FRAME | Steel |
| COLOUR | Blue |
| SEAT | Fabric seat with an extra cushion |
| ARMRESTS | Folding |
| WHEELS | Solid 12" |
| SPEED | 0,5 to 6km/h |
| AYTONOMY | 20km/h |
| INCLINE | to 10° |
| MOTOR | -- |
| BATTERY | 2 x 12V / 6 months warranty |

ADDITIONAL FEATURES

- Movement and lifting joystick
- Comfortable knee safety belt
- 2 motors and 2 batteries



| | | | | | | | | | | |
|---|---|---|---|---|---|---|---|---|---|---|
|  |  |  |  |  |  |  |  |  |  |  |
| 44cm | 44cm | 44cm | 52cm | 63cm | 107cm | 108cm | 77cm | 12"8" | 100kg | 80kg |

 74.5kg ref. **0811107** Power Wheelchair Agilia Red **New Products**











- Comfortable Deluxe seat
- Adjustable armrests
- Bonded footrests
- Joystick with rotating stick
- Suitable for narrow aisles and entrances
- Front Wheel Thickness: 50mm
- Rear Wheel Thickness: 85mm
- Front Wheel Diameter: 150mm
- Rear Wheel Diameter: 260mm
- Number of Motors: 2 - 2x270watts
- Number of Batteries: 2.32Ah



Power Wheelchairs Shoprider Scooters



Anti-tipping supporting casters

| | | | | | | | | | | | |
|---|---|---|---|---|---|---|---|---|---|---|---|
|  |  |  |  |  |  |  |  |  |  |  |  |
| 966x560x1016mm | 6" 8" Solid | 490x460x540mm (WxDxH) | 28Kg | 74.5Kg | 12V/10Ah(x2) | 6° | 6kph | 12-14km | | | |



Available upon request

205kg ref. **0811108** **Power Wheelchair Avidi** **New Product**

- Comfortable, safe
- Maximum User Weight up to 205Kg
- Suitable for various grounds and harsh surfaces, indoors and outdoors
- Front Wheel Thickness: 50mm
- Rear Wheel Thickness: 50mm
- Middle Wheel Thickness: 75mm
- Front Wheel Diameter: 175mm
- Rear Wheel Diameter: 175mm
- Middle Wheel Diameter: 355mm
- Number of Motors: 2 - 2x450watts
- Number of Batteries: 2.50Ah



Anti-tipping supporting casters



| | | | | | | | | |
|-------------------|-----------------|-----------------------|-------|-------|--------------|-----|--------|---------|
| | | | | | | | | |
| 1.050x640x1.170mm | 7"+14" 7" Solid | 530x530x530mm (WxDxH) | 106Kg | 205Kg | 12V/50Ah(x2) | 12° | 5-6kph | 26-28km |

90kg ref. **0811109** **Power Wheelchair Folding Flexy** **New Product**

- Innovative & ergonomic
- Easy to use
- Folding
- Suitable for movement in the city
- Easy to charge
- Easy to carry
- Simple seat
- Each colour change for the rear, front and side view using a Velcro technology.
- Front Wheel Thickness: 50mm
- Rear Wheel Thickness: 50mm
- Front Wheel Diameter: 150mm
- Rear Wheel Diameter: 200mm
- Number of Motors: 1 - 70watts
- Number of Batteries: 2.10Ah



| | | | | | | | | |
|-----------------|-------------|-----------------------|------|------|--------------|----|------|---------|
| | | | | | | | | |
| 1.110x445x880mm | 6" 8" Solid | 390x350x320mm (WxDxH) | 28Kg | 90Kg | 12V/10Ah(x2) | 6° | 6kph | 12-14km |



ref. 0811101

Power Wheelchair Folding Trendy

New Product

- 3 Covers included: Red / Silver / Blue
- Dismantling without tools
- Simple, rotating seat
- Each colour change for the rear, front and side view using a Velcro technology.
- Front Wheel Thickness: 60 mm
- Rear Wheel Thickness: 70 mm
- Front Wheel Diameter: 175 mm
- Rear Wheel Diameter: 200 mm
- Number of Motors: 1 - 200watts
- Number of Batteries: 2.14Ah



| | | | | | | | | |
|-----------------|-------------|-----------------------|------|-------|--------------|----|--------|---------------|
| | | | | | | | | |
| 1.120x560x840mm | 7" 8" Solid | 460x400x350mm (WxDxH) | 43Kg | 113Kg | 12V/14Ah(x2) | 6° | 6-7kph | 12-14km(14Ah) |



ref. 0811102

Power Wheelchair Actari 2 Red

New Product

- Comfortable seat
- Adjustable Low Captain seat
- Adjustable backrest
- Light & Turn lights
- Front Wheel Thickness: 100mm
- Rear Wheel Thickness: 100mm
- Front Wheel Diameter: 330mm
- Rear Wheel Diameter: 330mm
- Number of Motors: 1 - 350watts
- Number of Batteries: 2.50Ah



Anti-tipping supporting casters

| | | | | | | | | |
|-------------------|-----------------------|-----------------------|------|-------|--------------|----|-------------------------|---------|
| | | | | | | | | |
| 1.400x600x1.340mm | 12.5" 12.5" Pneumatic | 460x440x440mm (WxDxH) | 94Kg | 136Kg | 12V/50Ah(x2) | 9° | 6-7kph Upgrade 9-10km/h | 36-38km |

Power Wheelchairs Shoprider Scooters



Available upon request



ref. 0811103

Power Wheelchair Alluri

New Product

- Comfortable, Fast, Safe
- Emergency brake
- Adjustable steering wheel
- Rotating Deluxe seat
- Adjustable backrest
- Front Wheel Thickness: 100mm
- Rear Wheel Thickness: 75mm
- Front Wheel Diameter: 330mm
- Rear Wheel Diameter: 355mm
- Number of Motors: 1 - 750watts
- Number of Batteries: 2.75Ah
- Light & Turn lights



| | | | | | | | | |
|-------------------|---------------------|-----------------------|-------|-------|--------------|-----|----------|---------|
| | | | | | | | | |
| 1.400x700x1.330mm | 12.5" 14" Pneumatic | 500x440x500mm (WxDxH) | 116Kg | 225Kg | 12V/75Ah(x2) | 12° | 14-15kph | 59-62km |

Available upon request



ref. 0811104

Power Wheelchair Dakar

New Product

- Comfortable, Fast, Safe
- 4 Wheels
- Rotating Deluxe seat
- Adjustable backrest
- Folding steering wheel
- Complete lighting pack
- Front Wheel Thickness: 75mm
- Rear Wheel Thickness: 75mm
- Front Wheel Diameter: 355mm
- Rear Wheel Diameter: 355mm
- Number of Motors: 2 - 270/750watts
- Number of Batteries: 2.75Ah



| | | | | | | | | |
|-------------------|-------------------|-----------------------|-------|-------|--------------|-----|--------------|---------|
| | | | | | | | | |
| 1.450x680x1.300mm | 14" 14" Pneumatic | 500x440x500mm (WxDxH) | 157Kg | 200Kg | 12V/75Ah(x2) | 12° | 11.5-12.5kph | 37-39km |

Power Wheelchairs Shoprider Scooters



Available upon request

225kg ref. 0811105 **Power 2-Seater Wheelchair Imperial** **New Product**

- Larger seat for maximum comfort for 2-user seat
- Comfortable bench-seat
- Turn Signals & Alarm Light
- Front Wheel Thickness: 100mm
- Rear Wheel Thickness: 100mm
- Front Wheel Diameter: 330mm
- Rear Wheel Diameter: 330mm
- Number of Motors: 1 - 750watts
- Number of Batteries: 2.75Ah



| | | | | | | | | |
|-------------------|-----------------------|-----------------------|-------|-------|--------------|----|----------|---------|
| | | | | | | | | |
| 1.480x790x1.050mm | 12.5" 12.5" Pneumatic | 800x440x370mm (WxDxH) | 159Kg | 225Kg | 12V/75Ah(x2) | 6° | 11-12kph | 40-42km |

Available upon request

160kg ref. 0811106 **Power Wheelchair Maxi Cab** **New Product**

- Suitable for all seasons
- Adjustable steering wheel
- Complete lighting pack. Brake lights
- LED battery
- Additional comfortable Deluxe seat
- Possibility for windscreen washing with windscreen wipers
- Removable doors
- Front Wheel Thickness: 75mm
- Rear Wheel Thickness: 75mm
- Front Wheel Diameter: 355mm
- Rear Wheel Diameter: 355mm
- Number of Motors: 1 - 750watts
- Number of Batteries: 2.75Ah



| | | | | | | | | |
|-------------------|-------------------|-----------------------|-------|-------|--------------|-----|------------|---------|
| | | | | | | | | |
| 1.600x730x1.652mm | 14" 14" Pneumatic | 500x440x500mm (WxDxH) | 210Kg | 160Kg | 12V/75Ah(x2) | 12° | 14-14.5kph | 40-42km |

Power Wheelchairs Shoprider Scooters



ref. 0808313

Single Crank Metal Bed
(without rails and casters)

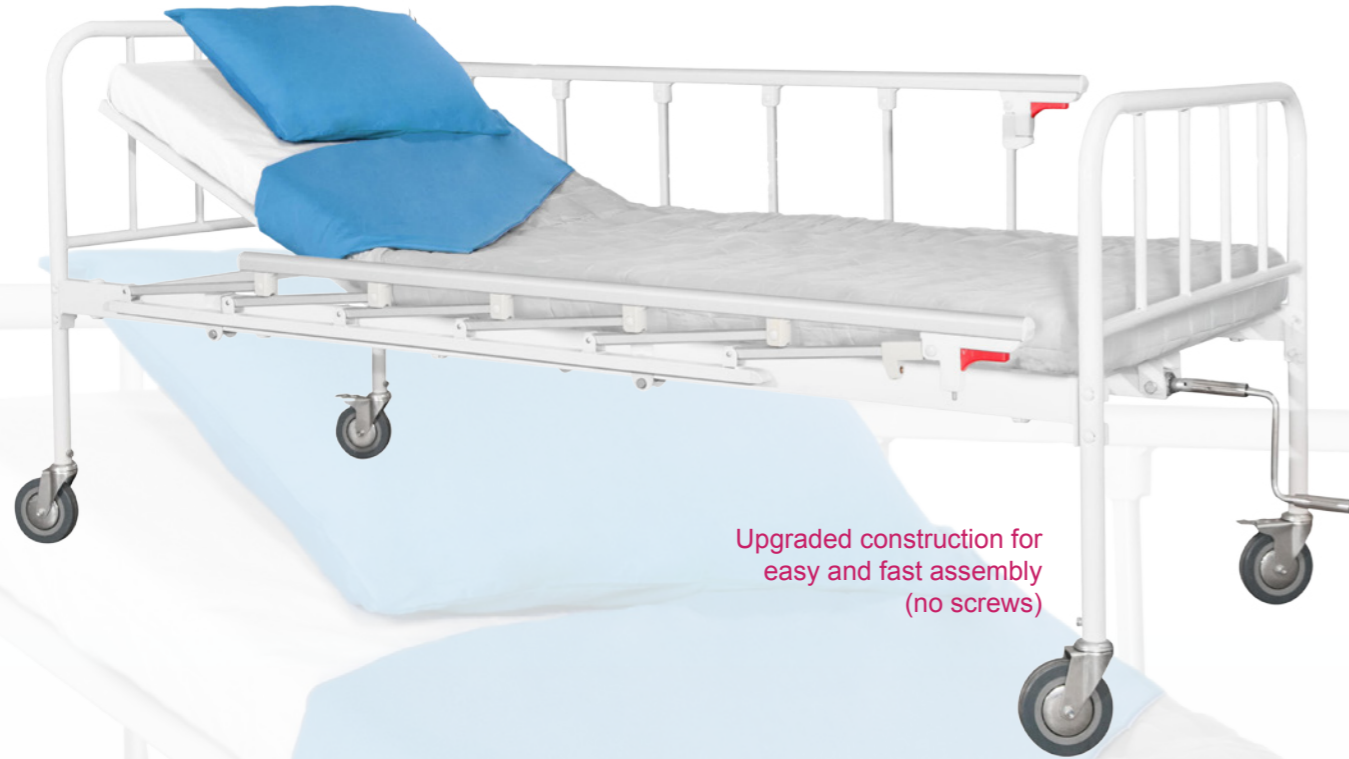

Upgraded construction for
easy and fast assembly
(no screws)

BEDS

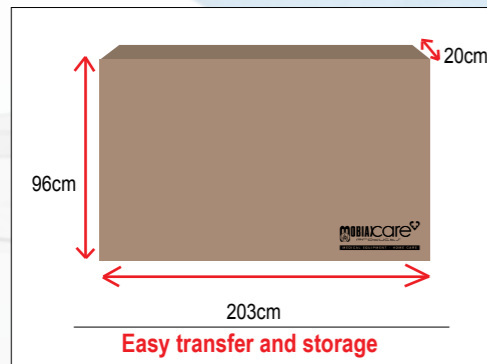

| Inter. Dimensions | Ext. Dimensions | Height from floor | Max. Patient Weight | Back Lift | Colour |
|-------------------|-----------------|---|---------------------|-----------------|--------|
| 195 x 85 cm | 200 x 92 cm | 33,5 cm (without casters) / 46 cm (with casters) | 120 Kg | Crank mechanism | White |

Bed with code 0808313 is available with 2 options in rails



Patient Beds
Tables-Bedside
Tables.
Bed Access.

ref. 0809254

External folding rails with hooks

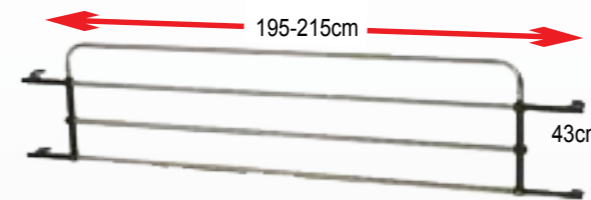

ref. 0806148

The package includes
a lifting pole and a mounting base

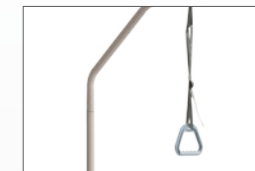

ref. 0807969

Folding rails

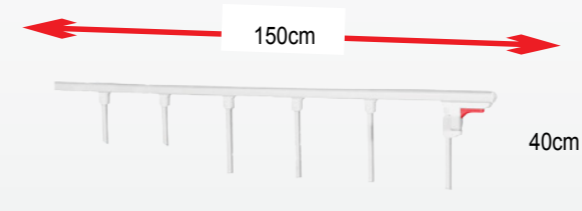

ref. 0807988

Caster with brakes





ref. 0810058

Single-Crank Bed One Piece
(without rails and casters)

New Product

| | |
|------------------------------------|-----------------|
| External Dimensions | L:200 x W:92 cm |
| Internal Dimensions | L:194 x W:85 cm |
| Height from the floor with casters | 58cm |
| Height from the floor with casters | 46cm |
| Maximum Patient Weight | 200Kg |
| Product Weight | 34Kg |
| Package Dimensions | 203x93 x17cm |
| Brown riser | |
| Headrest crank | |
| Caster with brakes | |



Upgraded construction for easy and fast assembly (no screws)

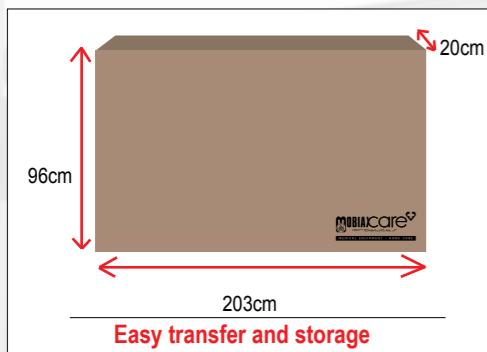

| Inter. Dimensions | Ext. Dimensions | Height from floor | Max. Patient Weight | Back Lift | Colour |
|-------------------|-----------------|--|---------------------|-----------------|------------|
| 194 x 85 cm | 200 x 92 cm | 46,0 cm (without casters) / 58 cm (with casters) | 200 Kg | Crank mechanism | Dark brown |

Bed with code 0810058 is available with 3 options in rails



Patient Beds
Tables-Bedside
Tables.
Bed Access.

ref. 0809254

External folding rails with hooks

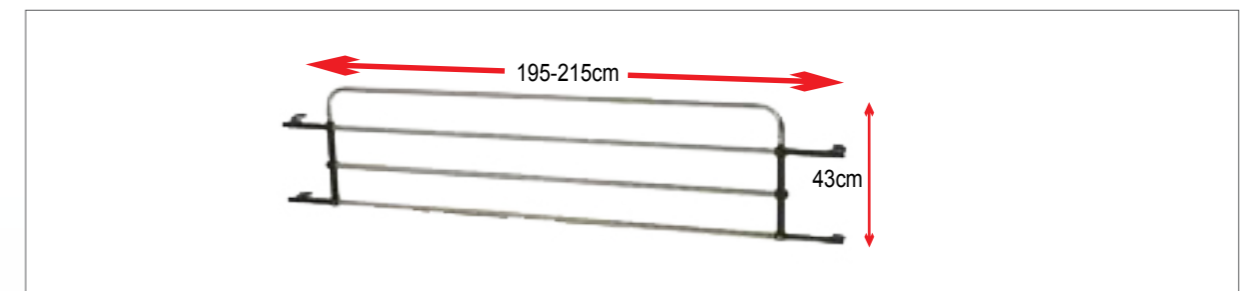

ref. 0810072

External folding rails, brown



ref. 0808600

Rails

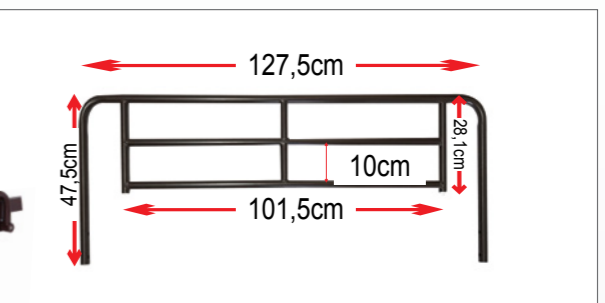

ref. 0809251

Lifting pole



ref. 0810571

Mounting base Brown



ref. 0810074

Caster with brakes





ref. **0810069**

Single Crank Metal Bed
(without rails and casters)

- Wooden frame at risers
- Slatted bed frame consists of 2 parts, for easy transfer and storage

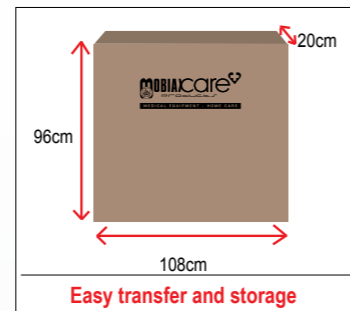

| Inter. Dimen. | Ext. Dimen. | Height from floor | Max. Patient Weight | Back Lift |
|---------------|-------------|--|---------------------|-----------------|
| 194 x 85 cm | 200 x 92 cm | 46,0 cm (without casters) / 58 cm (with casters) | 200 Kg | Crank mechanism |

Bed with code 0810068, 0810069 is available with 2 options in rails



Patient Beds
Tables-Bedside
Tables,
Bed Access.

ref. **0809254**

External folding rails with hooks

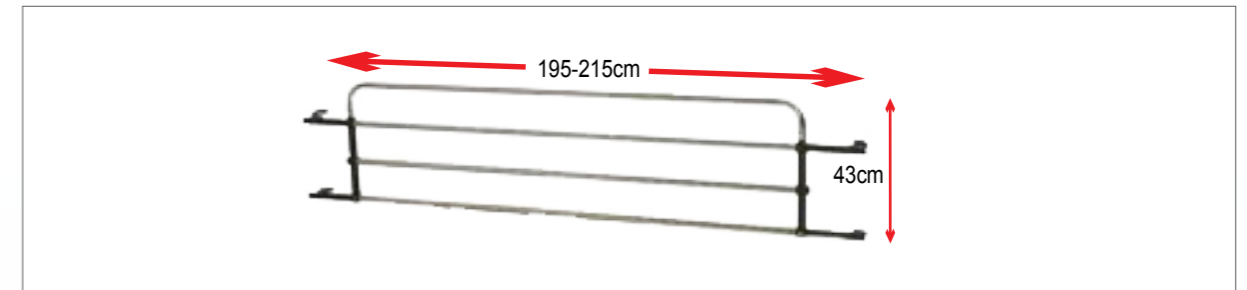

ref. **0810073**

External folding rails, beige

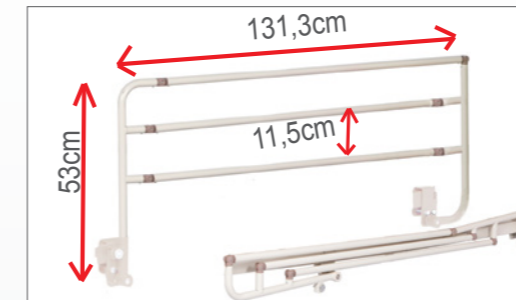

ref. **0810072**

External folding rails, brown

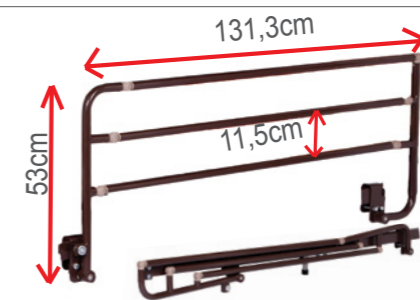

ref. **0809251**

Lifting pole



ref. **0810571**

Mounting base Brown



ref. **0810572**

Mounting base Beige



ref. **0810074**

Caster with brakes





ref. 0810070

Multi-Part Metal Bed
(without rails and casters)

- Wooden frame at risers
- Slatted bed frame consists of 2 parts, for easy transfer and storage



Central screwing only

Upgraded construction for easy and fast assembly



ref. 0810071

Multi-Part Metal Bed
(without rails and casters)

- Wooden frame at risers
- Slatted bed frame consists of 2 parts, for easy transfer and storage



Central screwing only

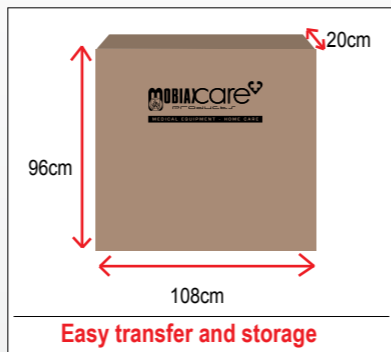

| Inter. Dimen. | Ext. Dimen. | Height from floor | Max. Patient | Back Lift |
|---------------|-------------|--|--------------|-------------------------|
| 194 x 85 cm | 200 x 92 cm | 46,0 cm (without wheels) / 58 cm (with wheels) | 200 Kg | Mechanically with crank |

Bed with code 0810070, 0810071 is available with 2 options in rails



Patient Beds
Tables-Bedside
Tables.
Bed Access.

ref. 0809254

External folding rails with hooks

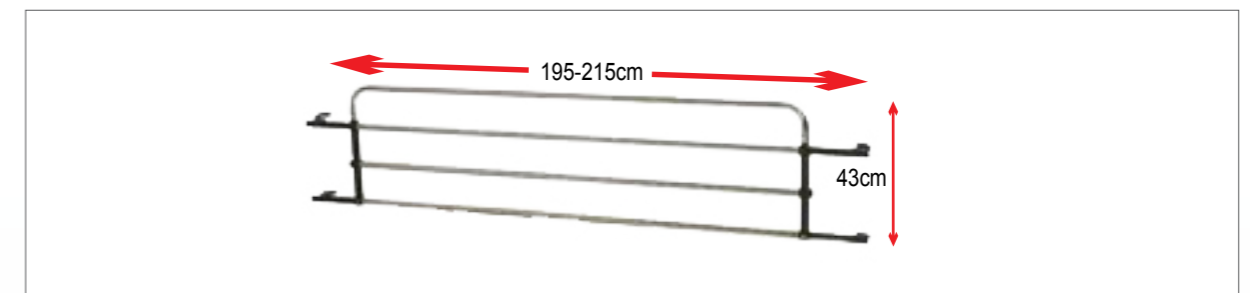

ref. 0810073

External folding rails, beige

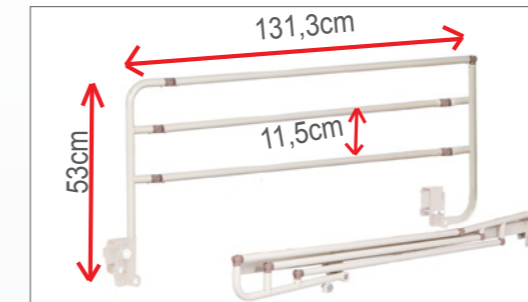

ref. 0810072

External folding rails, brown



ref. 0809251

Lifting pole



ref. 0810571

Mounting base Brown



ref. 0810572

Mounting base Beige



ref. 0810074

Caster with brakes





American Type



ref. **0808470** **Electric Multi-Folding Bed**

- With plastic risers in wood colour
- Rails and casters included

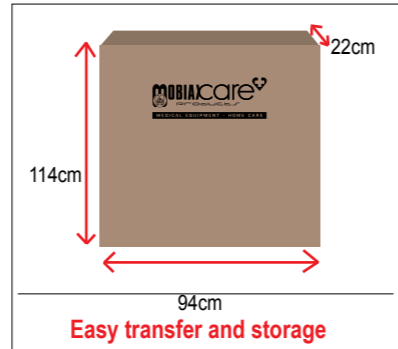

| Inter. Slatted bed frame Dimensions (LxW) | Ext. Slatted bed frame Dimensions (LxW) | Height from floor | Max. Patient Weight | Back / legs / knees elevation |
|---|---|---------------------------------------|---------------------|-------------------------------|
| 202 x 88 cm | 224 x 96 cm | Electrical lift between 39.5 and 57cm | 150 Kg | Electrical |



ref. **0808471** **Semi-Electric, Multi-Folding Bed**

- With plastic risers in wood colour
- Rails and casters included



Lifting pole (optional)
ref. 0808470
ref. 0808471

ref. **0809251**

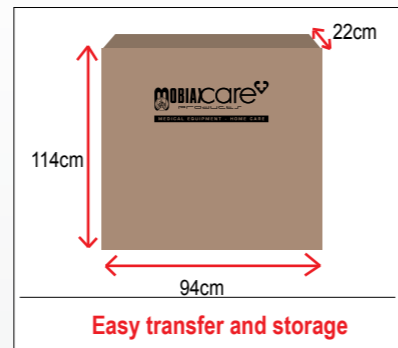

| Inter. Slatted bed frame Dimensions (LxW) | Ext. Slatted bed frame Dimensions (LxW) | Height from floor | Max. Patient Weight | Back / legs / knees elevation |
|---|---|---|---------------------|-------------------------------|
| 202 x 88 cm | 224 x 96 cm | Manual crank lift between 39.5 and 57cm | 150 Kg | Electrical |



ref. **0806449** **Electric Multi-Folding Bed**

- Anti-Trendelenburg function
- Trendelenburg function
- Wooden frame at risers
- I.V stand
- Folding rails and casters included
- Colour Dark brown

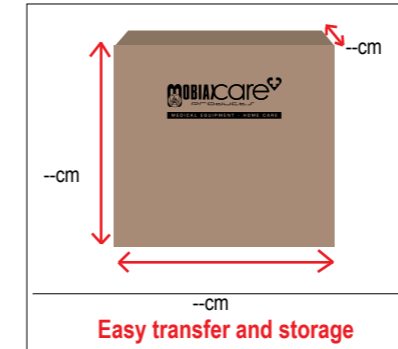

| Inter. Dimensions | Ext. Dimensions | Height from floor | Max. Patient Weight | Back / legs / knees elevation |
|-------------------|-----------------|-------------------|---------------------|-------------------------------|
| 200 x 90 cm | 218 x 92 cm | 36-76 cm | 200 Kg | Electrical |

Patient Beds
Tables-Bedside
Tables.
Bed Access.



ref. **0806450** **Electric Multi-folding Bed**

- Anti-Trendelenburg function
- Trendelenburg function
- Wooden frame at risers
- I.V stand
- Folding rails and casters included
- Beige colour

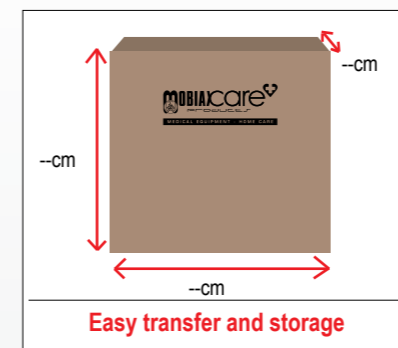

Lifting pole (optional)
ref. 0806449
ref. 0806450

ref. **0809251**

| Inter. Dimensions | Ext. Dimensions | Height from floor | Max. Patient Weight | Back / legs / knees elevation |
|-------------------|-----------------|-------------------|---------------------|-------------------------------|
| 200 x 90 cm | 218 x 92 cm | 36-76 cm | 200 Kg | Electrical |

ref. **0223000** **Manual Multi-Folding Bed (with 2 cranks)**



- Package includes:**
- Plastic ABS risers
 - Rails and casters
 - I.V stand and hangers for urine collectors



ref. **0806647** **Hospital Bedside table** **New Product**

- with metal side panels
- Wheeled
- 1-year warranty



ref. **0806148** **Lifting pole**

- Includes a mounting base
- Suitable for hospital beds with code 0806054, 022300

| Inter. Slatted bed frame Dimensions (LxW) | Ext. Slatted bed frame Dimensions (LxW) | Height from floor | Max. Patient Weight | Back / legs / knees elevation |
|---|---|-------------------|---------------------|-------------------------------|
| 194 x 84 cm | 215 x 100 cm | 50 cm | 180 Kg | Crank mechanism |

ref. **0806054** **Powered Multi-Folding Metal Bed**



- Package includes:**
- Plastic ABS risers
 - Rails and casters
 - I.V stand and hangers for urine collectors



Recommended for clinics/ nursing homes / rehabilitation centers

Patient Beds Tables-Bedside Tables, Bed Access.



ref. **0806647** **Hospital Bedside table** **New Product**

- with metal side panels
- Wheeled
- 1-year warranty



ref. **0806148** **Lifting pole**

- Includes a mounting base
- Suitable for hospital beds with code 0806054, 022300

| Inter. Slatted bed frame Dimensions (LxW) | Ext. Slatted bed frame Dimensions (LxW) | Height from floor | Max. Patient Weight | Back / legs / knees elevation |
|---|---|-----------------------------------|---------------------|-------------------------------|
| 194 x 84 cm | 216 x 100 cm | 46 - 72cm (Electrical adjustment) | 170 Kg | Electrical |

Bedside tables

Year
Warranty

1

www.mobiakcare.gr



ref. **0809243** Reclining Table Beige

New
Product

- Wheeled
- Special support for reading
- Dimensions (LxW): 80x39cm
- Adjustable height between 80 and 120cm
- Weight: 13Kg
- Max.Load: 15Kg



ref. **0808234** Fixed Table Beige

New
Product

- Wheeled
- Dimensions (LxW): 80x39cm
- Adjustable height between 80 and 120cm
- Weight: 10.8Kg
- Max.Load: 15Kg
- Warranty: 1 year



ref. **0806645** Reclining Table Brown

- Wheeled
- Special support for reading
- Dimensions (LxW): 80x38cm
- Adjustable height between 75 and 126cm
- Weight: 9.2Kg
- Max.Load: 12Kg



ref. **0806646** Fixed Table Brown

- Wheeled
- Dimensions (LxW): 77x38cm
- Adjustable height between 75 and 126cm
- Weight: 9.6Kg
- Max.Load: 12Kg

MOBIAKCARE[®]
MEDICAL EQUIPMENT

TABLE



ref. **0806392** **I.V Stand with 4 hangers plastic base**

Adjustable height 120-187cm
2.34Kg

ref. **0808235** **I.V Stand with 2 hangers Steel Base**

Adjustable Height 138-184cm
2.49Kg

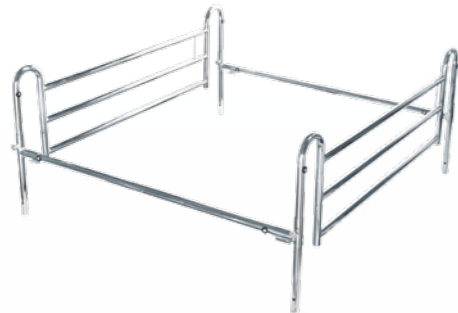

ref. **0807801** **External Folding Rails**

- Adjustable length from 115 to 195cm
- Adjustable width from 88 to 110cm
- Adjustable height in 2 positions: 25 and 46cm



ref. **0806669** **External Folding Rails for double bed (100-170 cm)**

- Suitable for all beds
- Metal, Chromium
- Adjustable length: 122cm to 183cm
- Adjustable width: 100cm to 170cm
- Height 40 cm



ref. **0809254** **External rails with hooks - Folding**

- Suitable for most steel beds
- With special folding system so that full removal is not necessary when transferring the patient to and from the bed
- Adjustable length from 195 to 215cm
- Packing 2 pcs.



ref. **0808195**

Freestanding Lifting Pole with Base

New Product

- Dimensions (LxWxH): 129x43x27cm
- Max. Load: 26Kg
- Product Weight: 23Kg
- Height from the floor: 174cm
- Base Width: 106cm
- Base Length: 135cm
- Maximum hanging weight: 136Kg

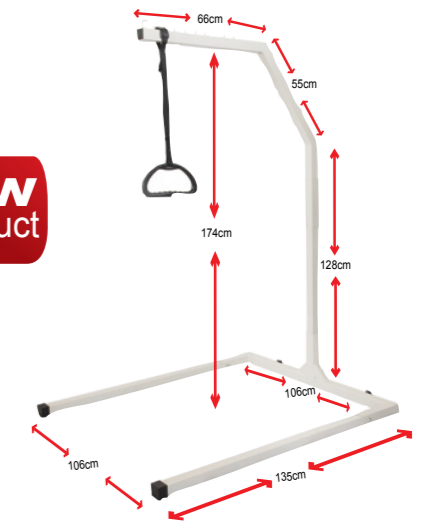

ref. **0809250**

Bed rail Assist

Straps secured under the mattress for a better fit.



Patient Beds
Tables-Bedside
Tables.
Bed Access.

ref. **0808341**

Back lift with spring

Dimensions (LxW): 60 x 55cm.



ref. **0806066**

Back lift

Dimensions (LxW): 56 x 59cm.





ref. **0804900** **Mobiak PEGASUS Patient Lift**

- Sling included
- Rechargeable battery
- Pneumatic - Electric
- Steel frame
- Wheeled, with brakes on the rear casters

| | | | |
|---|---------|---|---------|
| A | 70cm | G | 83cm |
| B | 61cm | H | 44,5cm |
| C | 91cm | I | 54,5cm |
| D | 84cm | L | 94cm |
| E | 175cm | M | 102,5cm |
| F | 116,5cm | O | 8cm |
| | | P | 13cm |

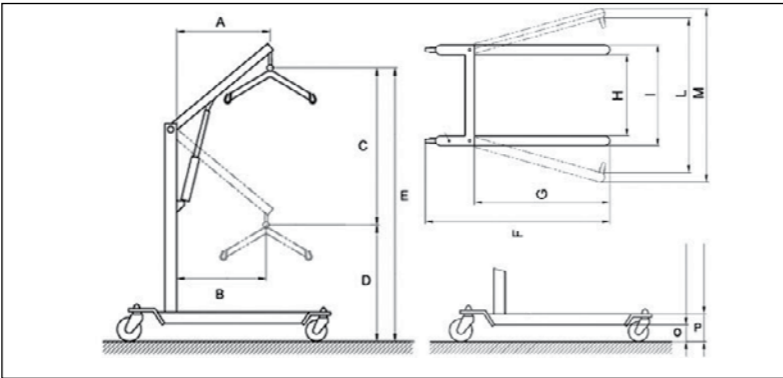

| | Warranty | Battery Warranty | Max Load Weight |
|----------------|----------|------------------|-----------------|
| 0804900 | 3 years | 6 months | 135 Kg |

ref. **0804902** **MOBIAK TALOS Patient Lift**

- Sling included
- Rechargeable battery
- Pneumatic - Electric
- Steel frame
- Wheeled, with brakes on the rear casters

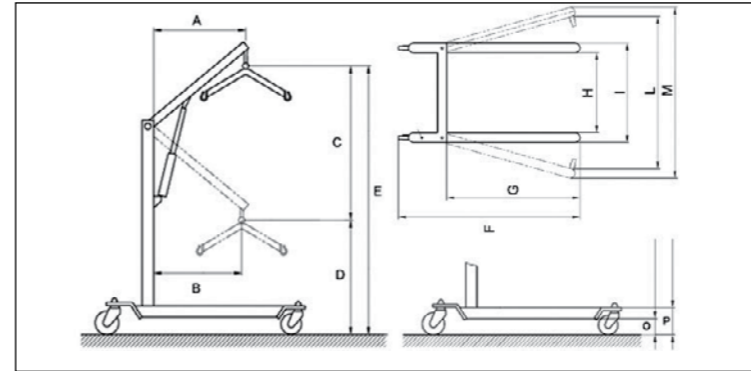

| | | | |
|---|-------|---|-------|
| A | 90cm | G | 94cm |
| B | 53cm | H | 54cm |
| C | 99cm | I | 62cm |
| D | 87cm | L | 107cm |
| E | 186cm | M | 117cm |
| F | 133cm | O | 8cm |
| | | P | 13cm |

| | Warranty | Battery Warranty | Max Load Weight |
|----------------|----------|------------------|-----------------|
| 0804902 | 3 years | 6 months | 180 Kg |



ref. **0808038** **Mobiak ATLAS Patient Lift**

- Sling included
- Rechargeable battery
- Pneumatic - Electric
- Steel frame
- Wheeled, with brakes on the rear casters

| | | | |
|---|-------|---|-------|
| A | 90cm | G | 94cm |
| B | 53cm | H | 54cm |
| C | 99cm | I | 62cm |
| D | 87cm | L | 107cm |
| E | 186cm | M | 117cm |
| F | 133cm | O | 8cm |
| | | P | 13cm |

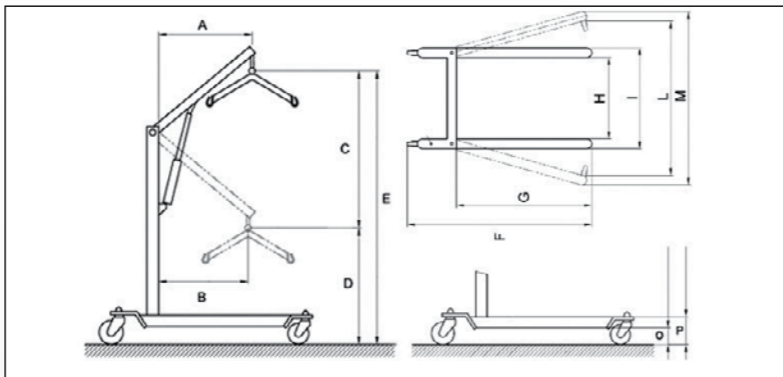

| | Warranty | Battery Warranty | Max Load Weight |
|----------------|----------|------------------|-----------------|
| 0808038 | 3 years | 6 months | 150 Kg |



ref. **0808094** **Sling Standard with headrest**

- Maximum patient weight 180Kg

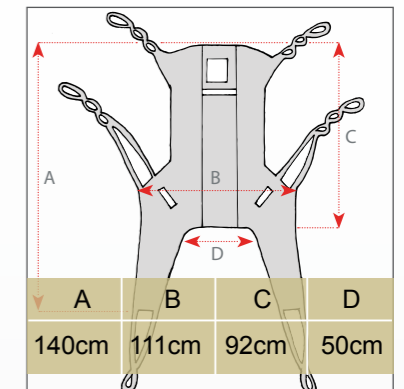
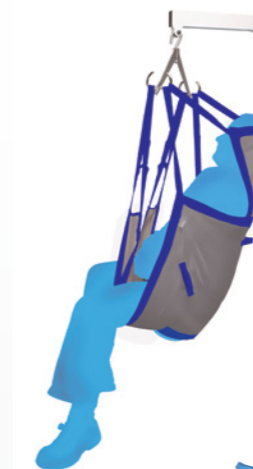

ref. **0810131** **Sling Full Body**

- 100% Polyester
- Covers the entire body, with a headrest for better support of the head.
- Maximum patient weight 250Kg

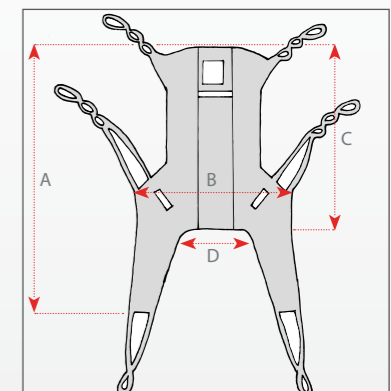



ref. **0223018** **Foam - Cocopalme mattress**

- Waterproof, breathable cover
- Dimensions: (LxWxH): 195 x 85 x 8cm

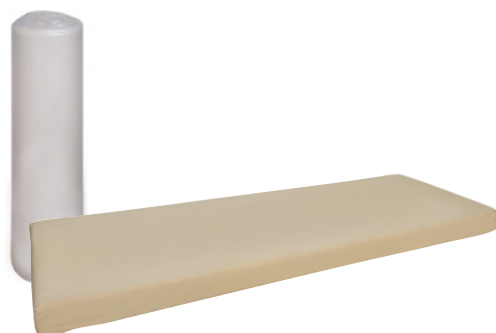

ref. **0808910** **Foam mattress Economic - Density 25D**

- Foam Dimensions (LxWxH): 195 x 86 x 10cm
- Fabric cover with zipper



ref. **0808911** **3 Section - Foam mattress Economic-Density 25D**

- Foam Dimensions (LxWxH): 195 x 86 x 10cm
- Fabric cover with zipper

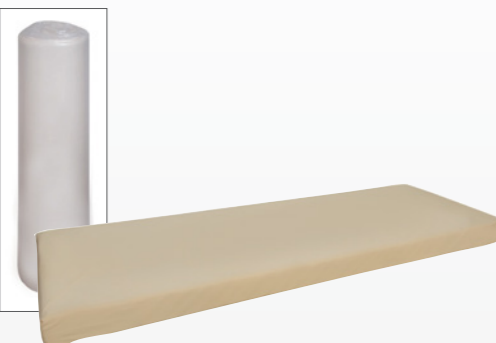

ref. **0808765** **Foam Mattress MEMORY**

- Foam Dimensions (LxWxH): 195 x 86 x 10cm
- Foam Thickness 6cm + Memory Foam Thickness 4cm
- Fabric cover with zipper

*All mattresses are compressed in a roll with nylon packaging in a carton box or in their normal size, depending on availability

ref. **0807863**

Mattress Cover Waterproof mattress cover - Single size

New Product

- Protects the mattress, ensuring hygiene and cleanliness
- Breathable material
- Easily fitted to the corners of the mattress thanks to the special rubber hooks, covering the surface.
- Prevents fluid inflow.
- One side is made of extra soft textile surface and the bottom side is covered by a waterproof liner
- Dimensions: 100x200cm



ref. **0807864**

Mattress Cover Waterproof, fabric material - Double-size

New Product

- Protects the mattress, ensuring hygiene and cleanliness
- Breathable material
- Easily fitted to the corners of the mattress thanks to the special rubber hooks, covering the surface.
- Prevents fluid inflow.
- One side is made of extra soft textile surface and the bottom side is covered by a waterproof liner
- Dimensions: 200x200cm



Mattresses - Pillows - Covers

ref. **0807865**

Waterproof Pillow cover

New Product

- Protects the cushion, ensuring hygiene and cleanliness
- Breathable material
- Easy placement thanks to zipper.
- Prevents fluid inflow.
- One side is made of extra soft textile surface and the bottom side is covered by a waterproof liner
- Dimensions: 70x50cm



ref. **0806634**

Waterproof mattress cover PVC

Dimensions (LxWxH): 200x90x10cm



ref. **0810700** **Gel & Memory Foam Anatomical Sleeping pillow with Aloe Vera cover** **New Product**



- Designed to support the natural position of the head and the neck
- The pillows are made of memory foam & gel on their surface
- Includes cover with zipper, keeping the pillow clean
- Dimensions (LxWxH): 60x40x10/12cm

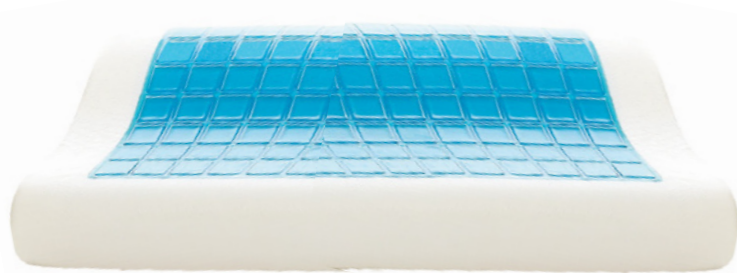

ref. **0810701** **Gel & Memory Foam Sleeping pillow with Aloe Vera cover** **New Product**



- Designed to support the natural position of the head and the neck
- The pillows are made of memory foam & gel on their surface
- Includes cover with zipper, keeping the pillow clean
- Dimensions (LxWxH): 60x40x12cm

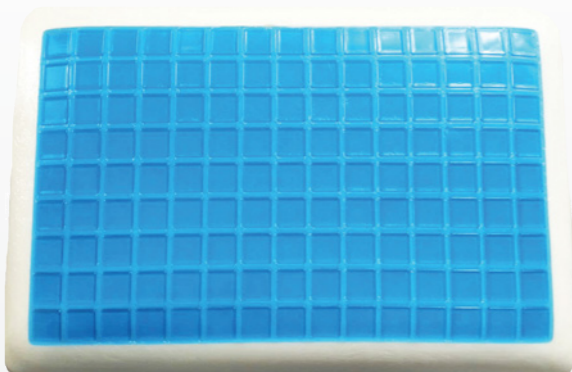

ref. **0806052** **Standard Pillow**

- Memory Foam - Anatomic
- Dimen.(LxWxH): 50x30x10cm
- Designed to support the head and neck in their normal position

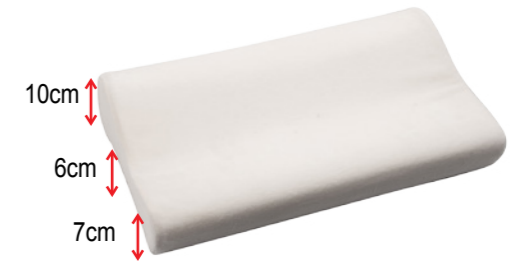

ref. **0806051** **King Size Pillow**

- Memory Foam - Anatomical
- Dimen.(LxWxH): 60x40x10cm
- Designed to support the natural position of the head and the neck

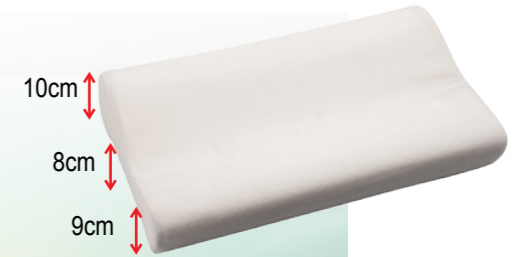

ref. **0806071** **“Aloe Vera” Pillow**

- Memory Foam
- Dimen.(LxWxH): 60x40x12cm
- Aloe Vera cover



Mattresses - Pillows - Covers

ref. **0808301** **CPAP Use Pillow**

- Memory Foam - Anatomical
- Use with apnea devices
- Hypoallergic
- Equipped with special pockets for the air tube
- Dimensions (LxWxH): 60x34x7cm



Memory Foam Material

- Adjusted in head's and neck's natural temperature and shape, and returns to its original dimensions in only a few seconds, providing a comfortable and relaxing sleep.
- Equally distribute the height and annihilate the pressures at head and neck by relaxing the muscles.
- Improves the blood circulation and relieves from pains and aches in these parts of the body.



*All pillows are made from 100% Memory foam and are equipped with removable, washable fabric cover with zipper.



ref. 0810702

Lumbar Roll Cushion New Product



- Includes cover with zipper, keeping the cushion clean
- It is placed on the chair to support the natural position of the lumbar part
- With adjustable strap
- Dimensions (LxWxH): 30x9x9cm



ref. 0806159

Seat Cushion



- Zipped case
- Secured on the chair with a rubber strap
- Supports the natural position of the lumbar part
- Dimensions (LxWxH): 34x30x12cm



ref. 0808320

Neck Pillow (Travel)

- Memory Foam
- Velvet or fabric case with zipper, depending on availability.
- Dimensions (LxWxH): 30x30x12cm



ref. 0806067

Knee Cushion (devider)

- Memory Foam
- Velvet or fabric case with zipper, depending on availability.
- Dimensions (LxWxH): 25x20x15cm or 25x20x7.5cm



ref. 0806068

Leg abduction cushion

- Zipped cover (PU Fabric)
- Dimensions (LxWxH): 56 x 18 top / 38 bottom x 13cm



ref. 0807949

Reclined Bed Cushion

- In black or white color, depending on the availability.
- Zipped
- Dimensions (LxWxH): 60x60x30cm

ref. 0807491

Protector for heel or elbow

- Per pair



ref. 0806140

Pressure sore Ring Cushion

New Product

- Dimensions: 45cm

ref. 0806514

Pressure sore Ring Cushion

New Product

- Dimensions: 42.5cm
- Pressure Sore Ring Rubber Cushion
- 0810546 pump and special valve are included in the packaging.



ref. 0807612

Seat Cushion

- Memory Foam with Integrated Gel
- Zipped case
- Dimensions (LxWxH): 45x40x7.5cm



ref. 0806161

Seat Cushion

- Memory Foam
- With Hole
- Velvet or fabric case with zipper, depending on availability
- Dimensions (LxWxH): 38x32x8cm



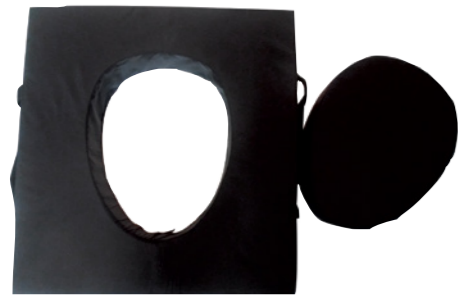

ref. 0806203 **Wheelchair Cushion with Hole**

- Zipped cover
- Dimensions (LxWxH): 44x47x7.5cm



ref. 0806931 **Pressure sore cushion with Laser Technology (Striped - Air-Pump Ventilated)**

- Features micro-holes opened with LASER technology, not visible at various points, enabling the patient's ventilation and the inhibition of moisture-induced pressure sore.
- Equipped with zipped case
- Equipped with air pressure regulator, depending on the patient's needs
- Operating Voltage 220v
- Dimensions (LxWxH): 46x46x8cm
- 2-year warranty



Pressure Sore Cushions offer:

- Effective pressure displacement
- Skin & Tissue Protection
- Relief & Comfort



ref. 0810010 **Pressure Sore Cushion with Gel & Air Cozy** **New Product**

- Unique combination of Air and Gel provides effective relief and comfort from the pressure on the high-risk user.
- Interconnected air cells provide high pressure relief, while inside Gel not only offers better comfort but also helps maintain body temperature better than air alone.
- Each air cell consists of 3 polyurethane (PU) layers for wear-resistance.
- Protective PU coating for easy cleaning and suitable for people with incontinence.
- Lightweight and easy to carry.
- Easy adjustment with air settings for greater comfort.
- Includes outer cover and the pump.
- Dimensions (LxWxH): 41x41x5cm

- Including:
- Stretch Cover (6 -month warranty)
 - Repair Kit
 - Manual air plunger (6-month Warranty)



Supplied in Color Box



ref. 0810013 **Pressure Sore cushion Gel - Tech I** **New Product**

- Dimensions (LxWxH): 40x40x1.6cm



ref. 0810014 **Pressure Sore Cushion Gel - Tech II** **New Product**

- Dimensions (LxWxH): 46x40x1.6cm

- The cushion is made of high quality polyurethane Gel.
- The surface is solid, smooth and helps recovery by providing optimal pressure distribution and perfect comfort.
- Actual Gel contained will not move, leak, evaporate, solidified or dry out if the pad is accidentally punctured.
- The material is highly resistant to bacteria and body fluids, and can be easily cleaned with water and soap or a mild antibacterial liquid.
- Material: Polyurethane Gel
- Stretch Cover included (6-month Warranty)

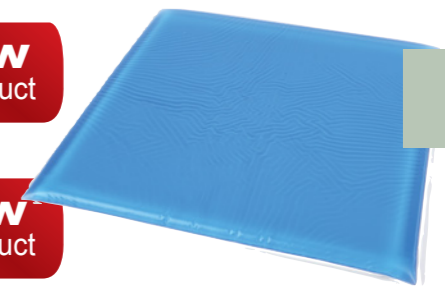

Supplied in Color Box

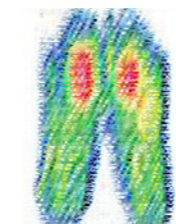

Without cushion

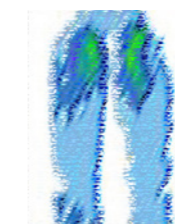

With cushion

New Technology **3D**

3D Gel cushions consist of 2 levels, combining the "cell technology" and Gel providing an excellent solution for reducing Skin and tissue stress.

- Three-dimensional (3D) design of "honeycomb" type
- 1. Allows the horizontal and vertical ventilation of the seat
- 2. Prevents sweating
- 3. Equal pressure distribution



Supplied in Color Box

130kg ref. **0810011** **Pressure Sore Cushion Gel - Tech I 3D** **New Product**

- Dimensions (LxWxH): 42x40x2cm

130kg ref. **0810012** **Pressure Sore Cushion Gel - Tech II 3D** **New Product**

- Dimensions (LxWxH): 46x42x2cm

13D Cell level & 1 Gel Level

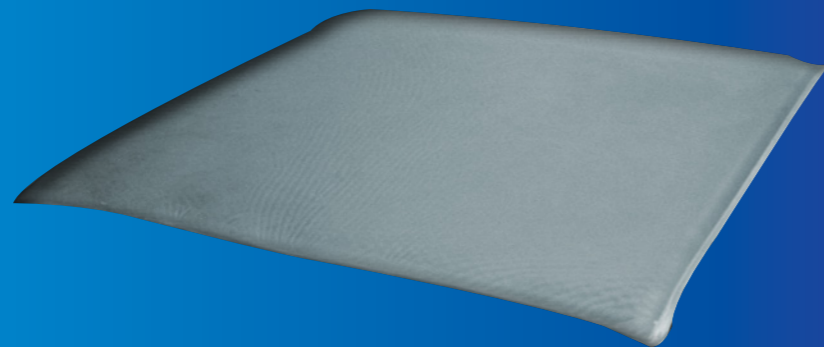

Maximum Pressure Distribution

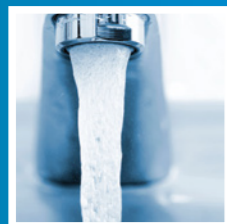

Easy washing & drying



Breathable material

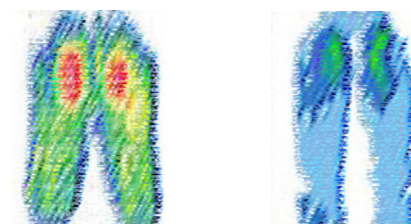

Without cushion

With 3D Gel

Applications

- Ideal for long flights
- Ideal for long flights
- Prevents bedsores
- Ideal for long driving hours
- Ideal for Camping

Pressure Sore Cushions offer:

- Effective pressure displacement
- Skin & Tissue Protection
- Relief & Comfort

130kg ref. **0810015** **Pressure Sore cushion with air cells Ergo-Lite** **New Product**

- Deluxe cushion provides maximum protection to the skin and soft tissue and the stability required for patients with intense activity, minimizing the side and back-forth motion.
- Pelvis is accommodated in the rear part of the wheelchair thanks to its anatomical design.
- Material: PVC
- Stretch Cover included (6-month Warranty)
- Repair Kit
- Manual air plunger (6-month Warranty)
- Dimensions (LxWxH): 46x40x6/10cm



Supplied in Color Box



130kg ref. **0810016** **Pressure Sore Cushion with Air cells Comfy I** **New Product**

- Dimensions (LxWxH): 40x40x8cm

130kg ref. **0810017** **Pressure Sore Cushion with Air cells Comfy II** **New Product**

- Dimensions (LxWxH): 46x40x8cm

- The air cell cushion can be adjusted to individual needs by adjusting the air volume.
- It soothes and relieves patient pressure from a sedentary position.
- Material: PVC
- Stretch Cover included (6-month Warranty)
- Repair Kit
- Manual air plunger (6-month Warranty)



Supplied in Color Box





- Available upon request

ref. 0810770

Pressure Sore Bariatric
Mattress DOMUS 3-2

New
Product
- ref. 0810771

Pressure Sore Bariatric
Mattress DOMUS 3-3

New
Product



Mattress Technical Specifications

(LAR172 and LAR174)

- Material: Nylon® + TPU
- Number of cells: 20 (9 with micro-holes)
- Valve: CPR
- Deflation time approx. 50 sec.
- Mattress weight: 6.9 kg
- Maximum Patient Weight: 200 kg
- Stage I, II and III System.
- Mattress with interchangeable cells and a pump for pressure settings.
- The pressure can be adjusted according to the patient's weight.
- Waterproof and breathable.
- Can be used without an extra mattress.
- The mattress has a cushion function for the first 3 cells. The remaining mattress is divided into two alternating parts which operate with two or three ways.
- Static operation enabled.



0810770

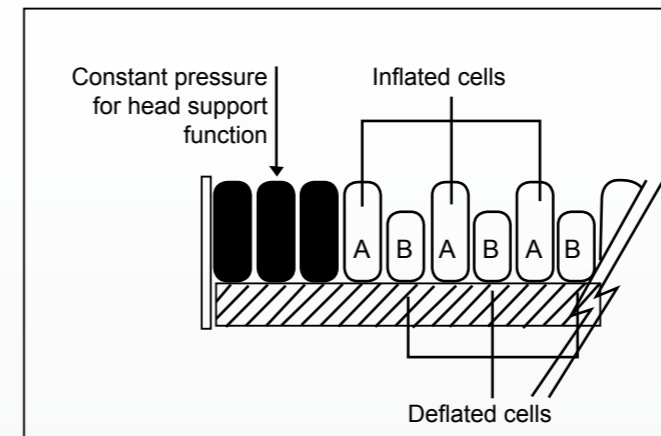

0810771

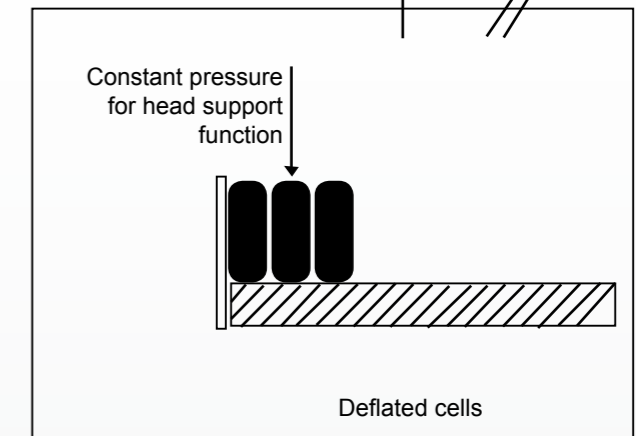

Pump Technical Specifications

(LAR270-2 and LAR270-3)

- Power: 220-240V / 50Hz
- Pressure: 30-80mmHg (2 psi)
- Power supply cable: 4.9m
- Air Flow: > 8LPM
- Cycle duration: 9.6 minutes
- Fuse: T1AL 250V
- Weight: 2.2 kg
- 2-year warranty

| | Dimensions (LxWxH) |
|----------------|-----------------------|
| 0810770 | 2000x900x203mm |
| 0810771 | 2000x900x203mm |
| pump | 280x126x185mm |



ref. **0223005** **Pressure Sore Mattress MOBIACARE with cells and air pump (set)**

- Maximum Patient Weight 120kg
- Dimensions (LxW): 235x95cm



ref. **0807750** **Air cell Spare mattress**

- 6-month Warranty



ref. **0223021** **Spare pump MOBIACARE**

- 2-year warranty



ref. **0810078** **Spare Filter for Air-pump**

- For mattresses with code 0223005, 0806591, 0810160.



ref. **0806591** **Pressure Sore Mattress with strips and air pump**

- Mattress Dimensions (LxWxH): 190 x 94 x 11 cm
- Flap dimensions (LxW): 53 x 94 cm
- Mattress is fixed tightly with 2 flaps.
- Zipped cover (Nylon-PU, waterproof)
- Maximum Patient Weight 150kg
- Dimensions (LxW): 200x95cm



ref. **0808279** **Spare Mattress with strips**

- 6-month Warranty



ref. **0808578** **Stripped Air-mattress Spare pump**

- 2-year warranty

ref. **0810160**

Pressure Sore mattress Laser (Stripped - Ventilated)

- Mattress Dimensions (LxWxH): 190 x 94 x 11 cm
- Flap dimensions (LxW): 53 x 94 cm
- Mattress is fixed tightly with 2 flaps.
- Features micro-holes opened with LASER technology, not visible at various points, enabling the patient's ventilation and the inhibition of moisture-induced pressure sore
- Equipped with zipped case.
- Equipped with air pressure regulator, depending on the patient's needs
- Maximum Patient Weight: 150Kg
- Warranty: 2 years (air pump)



ref. **0808578**

Stripped Air-mattress Spare pump

- 2-year warranty

ref. **0810561**

Spare mattress with laser

- 6-month Warranty



ref. **0808024**

Pressure Sore Mattress with strips (Bariatric - Mobicare Level II & III)

- Equipped with a CPR valve



Items for bed sore patients

Mechanism Technical Specifications

| | Pump Warranty | Power Supply | Pressure | Alarms | Mechanism Dim. (LxWxY) | Weight |
|---------|---------------|---------------|------------|-----------------------------|------------------------|--------|
| 0810156 | 1 year | 230V 50-60 Hz | 10-70 mmHg | Low pressure, power failure | 29,1x20x11,7cm | 2,2kg |

Mattress Technical Specifications

| | Warranty | Dimensions (LxWxY) | Material | Mattress weight | Maximum Patient Weight |
|---------|----------|--------------------|------------|-----------------|------------------------|
| 0810166 | 6 months | 200x85x15,2 cm | Nylon + PU | 9 kg | 180 kg |



ref. 0809176 **Steel Fixed Toilet ECO**

- Height-adjustable frame
- Available in grey colour

| | | | | | |
|------|------|------|---------|-------|---------|
| | | | | | |
| 46cm | 40cm | 62cm | 41-56cm | 7,0Kg | 110,0Kg |



ref. 0809155 **Fixed Folding Toilet**

- Height-adjustable
- Folding frame
- Available in white or grey plastic parts, depending on the availability

| | | | | | |
|------|------|------|---------|-------|---------|
| | | | | | |
| 45cm | 41cm | 55cm | 42-52cm | 7,0Kg | 100,0Kg |



ref. 0808525 **Fixed Reinforced Toilet**

- Height-adjustable

| | | | | | |
|------|------|------|---------|-----|---------|
| | | | | | |
| 46cm | 40cm | 54cm | 40-56cm | 7Kg | 135,0Kg |



ref. 0808524 **Heavy Duty Toilet**

- Folding armrests
- Height-adjustable

| | | | | | |
|------|------|------|---------|-----|---------|
| | | | | | |
| 65cm | 46cm | 80cm | 49-60cm | 9Kg | 225,0Kg |



ref. 0809156 **Wheeled Folding Toilet**

- Brakes on the rear casters
- Height-adjustable
- Folding frame
- Available in white or grey plastic parts, depending on the availability

| | | | | | |
|------|------|------|---------|-------|---------|
| | | | | | |
| 45cm | 41cm | 55cm | 49-59cm | 8,0Kg | 110,0Kg |



ref. 0809177 **Multi-Purposes Toilet**

New Product

- Can be used as: 1) Walker, 2) toilet chair, 3) Bathtub chair, 4) Raised toilet seat, 5) 2-Level & Step-by-Step waker
- Maximum Patient Weight 100Kg

| | | | | |
|------|------|------|---------|-------|
| | | | | |
| 60cm | 45cm | 63cm | 85-95cm | 100Kg |





ref. **0808587** Wall-mounted PVC Support Handle(wearproof) - 41cm

- Total Length 48,5cm

ref. **0808588** Wall-mounted PVC Support Handle(wearproof) - 46cm

- Total Length 54cm



ref. **0808509** Wall-mounted Handle with suction cups 40.6cm



ref. **0808520** Bathtub Support Handle - 34cm

- Easy installation without tools
- Suitable for most common bathtubs



ref. **0808141** Folding wall-mounted handle - 76cm



ref. **0806869** Handy Grip (Reacher) - 64.50cm

ref. **0810546** Pump



ref. **0806233** Inflatable Shampoo Washing Basin

- With drainage valve & tube for easy and fast water drainage.
- Mouth-inflation or using the pump with code 0810546



ref. **0808511** Arm Cover for Adults - Waterproof

- Length 56cm

ref. **0808512** Arm Cover for Kids - Waterproof

- Length 45cm



Toilets - Bathroom Aids

ref. **0808513** Leg Cover for Adults - Waterproof

- Length 58,4cm

ref. **0808514** Leg Cover for Kids - Waterproof

- Length 45cm





ref. **0808231** **Raised Toilet Seat with side clamps 10cm**

ref. **0808345** **Raised Toilet Seat with side clamps 15cm**



ref. **0808183** **Raised Toilet Seat with clamps and lid 10 cm**

ref. **0808184** **Raised Toilet Seat with clamps and lid 15 cm**



ref. **0806702** **Seat with armrests 10cm**



ref. **0808340** **Foam Raised Toilet Seat 10cm**

- Soft
- Waterproof washable case
- Velcro straps for easy placement on the seat of any toilet.



ref. **0808317** **Raised Toilet Seat PU10cm**

- Soft

ref. **0806070** **Raised Toilet Seat with front clamp 10cm**



ref. **0809349** **Unisex Urinal Chamber Pot**

- With special accessory for female use



ref. **0809535** **Bed Pan**

- Dimensions (LxWxH): 37 x 24 x 6cm



Toilets - Bathroom Aids

ref. **0810224** **Bed Pan**

- Length 31cm
- Width 23/15 cm
- Thickness 7/3 cm





ref. **0808135** **Rotating and Adjustable Bathtub Chair**

- Special adjustable base with width from 66 cm to 76cm
- Maximum Patient Weight 113Kg

| | | | | |
|------|------|---------|------|-------|
| | | | | |
| 40cm | 40cm | 66-76cm | 37cm | 113Kg |



ref. **0810067** **Bathtub Transfer Chair**

- With suction cups for greater stability
- Height-adjustable

| | | | | |
|------|------|------|---------|---------|
| | | | | |
| 70cm | 40cm | 75cm | 43-56cm | 100,0Kg |



ref. **0806064** **Shower chair with backrest**

- Height-adjustable

| | | | | | | |
|---------|---------|------|------|---------|------|-------|
| | | | | | | |
| 43-46cm | 43-46cm | 51cm | 30cm | 34-51cm | 33cm | 100kg |



ref. **0808523** **Heavy duty Shower chair with backrest**

- Height-adjustable
- With suction cups for greater stability

| | | | | | |
|------|------|------|------|---------|-------|
| | | | | | |
| 40cm | 42cm | 50cm | 30cm | 37-50cm | 225kg |

ref. **0806065** **Fixed Bathtub Bench**

- Weight 1,44 Kg

| | | | | |
|------|------|------|---|------|
| | | | | |
| 40cm | 21cm | 75cm | - | 75Kg |

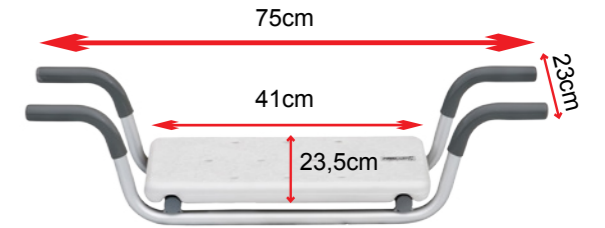

ref. **0808366** **Adjustable bathtub bench**

- Weight 1,40 Kg

| | | | |
|--------|------|---------|-------|
| | | | |
| 69,5cm | 26cm | 41-62cm | 113Kg |

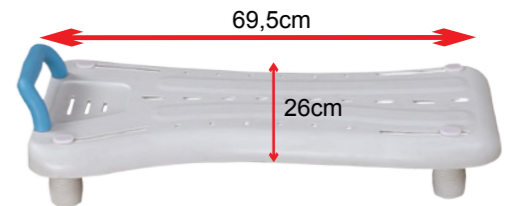

ref. **0807545** **Shower chair (Stool)**

- 1-year warranty
- Height-adjustable

| | | |
|-------|---------|-------|
| | | |
| Φ32cm | 35-53cm | 110kg |



ref. **0806505** **Shower Chair**

- Height-adjustable

| | | | |
|------|------|---------|-------|
| | | | |
| 50cm | 30cm | 34-44cm | 100kg |



ref. **0808678** **Wall-Mounted Shower chair**

- Folding
- Wall-mounted base
- Height-adjustable

| | | | |
|------|------|------|-------|
| | | | |
| 50cm | 31cm | 38cm | 113kg |



ref. **0809360** **Folding Walker**

- Folding frame
- Height-adjustable

| | | | | |
|------|--------|------|---------|-------|
| | | | | |
| 56cm | 44,5cm | 47cm | 75-94cm | 110Kg |

ref. **0806508** **Folding Walker with handles**

- Folding frame with release levers
- Height-adjustable

| | | | | |
|------|------|------|---------|-------|
| | | | | |
| 53cm | 46cm | 34cm | 77-95cm | 100Kg |

ref. **0807998** **Folding Walker 2 levels**

- Folding frame with 2-level handles for easy use
- Height-adjustable

| | | | | |
|------|------|------|---------|-------|
| | | | | |
| 54cm | 44cm | 37cm | 72-90cm | 100Kg |

ref. **0809396** **Walker with "Step-By -Step" Motion**

- Optional walking movement at the arms
- Folding frame
- Height-adjustable

| | | | | |
|------|------|------|---------|-------|
| | | | | |
| 54cm | 46cm | 34cm | 76-93cm | 100Kg |

ref. **0808526** **Folding Walker**

- Folding frame for easy use
- Height-adjustable

| | | | | |
|------|--------|------|---------|-------|
| | | | | |
| 56cm | 44,5cm | 49cm | 79-98cm | 225Kg |

ref. **0808690** **Reinforced Walker Small**ref. **0808691** **Reinforced Walker Medium**ref. **0808692** **Reinforced Walker Large**

- Fixed frames
- Height-adjustable

| | | | | | |
|----------------|------|------|------|----------|-------|
| | | | | | |
| 0808690 | 55cm | 38cm | 40cm | 60-68cm | 100Kg |
| 0808691 | 62cm | 39cm | 43cm | 80-88cm | 100Kg |
| 0808692 | 71cm | 42cm | 46cm | 92-100cm | 100Kg |

ref. **0806507** **Wheeled Folding Walker**

- Large 5" casters
- Height-adjustable

| | | | | |
|------|------|------|---------|-------|
| | | | | |
| 60cm | 47cm | 52cm | 80-95cm | 100Kg |

ref. **0808819** **Infant Wheeled Walker**

- Height-adjustable

| | | | | |
|------|------|------|---------|-------|
| | | | | |
| 56cm | 35cm | 35cm | 41-51cm | 100Kg |





ref. **0809175** **Rollator Walker**

- Dark red colour
- Rollator with brakes on the handles
- With seat, basket and backrest
- Height-adjustable handles

| | | | | | |
|------|------|------|---------|-----|-------|
| | | | | | |
| 46cm | 64cm | 56cm | 83-93cm | 6Kg | 100Kg |



ref. **0810616** **Rollator Walker** **New Product**

- Blue colour
- Rollator with brakes on the handles
- With seat and basket
- Height-adjustable handles

| | | | | | |
|------|------|------|---------|-----|-------|
| | | | | | |
| 46cm | 64cm | 56cm | 83-93cm | 6Kg | 100Kg |



ref. **0810615** **Double Formation Rollator Walker**

- Blue colour
- Height-adjustable handles
- Rollators with brakes on the handles
- With seat and basket
- Ability to transfer the user
- Double direction backrest, which transform the rollator to a transfer wheelchair
- Paint based on nanotechnology, which makes it more resistant

| | | | | | |
|------|------|------|----------|-----|-------|
| | | | | | |
| 41cm | 64cm | 52cm | 97-107cm | 7Kg | 100Kg |



Totally resistant paint

ref. **0808368** **Double Formation Rollator Walker**

- Height-adjustable handles
- Rollators with brakes on the handles
- With seat and basket
- Ability to transfer the user
- Double direction backrest, which transform the rollator to a transfer wheelchair
- Paint based on nanotechnology, which makes it more resistant



| | | | | | |
|------|------|------|----------|-----|-------|
| | | | | | |
| 41cm | 64cm | 52cm | 97-107cm | 7Kg | 100Kg |

ref. **0810617** **3-Wheels Rollator Walker**

- Blue colour
- Height-adjustable handles with brakes
- Equipped with basket and bag
- 200x50mm Wheels

| | |
|---------|-------|
| | |
| 85-95cm | 110Kg |



With reinforced wheels

ref. **0808717** **3-Wheels Rollator Walker**

- Height-adjustable handles with brakes
- Equipped with basket and bag

| | |
|---------|-------|
| | |
| 85-95cm | 110Kg |



With reinforced wheels

ref. **0807567** **Rollator Walker (forearm grip)**

- Rollator with brakes on the handles, seat and basket
- With forearm support
- Reinforced wheels

| | | | |
|------|------|-----------|-------|
| | | | |
| 42cm | 60cm | 100-115cm | 100Kg |



Walkers

ref. **0810007** **Rehabilitation walker**

- Comfortable seat and handles





| | | | |
|------|------|-----------|-------|
| | | | |
| 63cm | 85cm | 104-120cm | 100Kg |





ref. **0810066**



**Crutch
4-legs**

| | | | |
|---|---|---|---|
|  |  |  |  |
| 22x16cm | 79-102cm | 57-80cm | 100Kg |



ref. **0809667**

**Cane
4-leg
Swan
Large Base**

| | | |
|--|---|---|
|  |  |  |
| 30x22cm | 74-97cm | 100Kg |



ref. **0806510**

**Cane
4-legs
Straight handle**

| | | |
|---|---|---|
|  |  |  |
| 22,5x30cm | 69,5-91,5cm | 100Kg |



ref. **0809361**

**Cane
4-leg
Swan**

| | | |
|--|---|---|
|  |  |  |
| 20x17cm | 73-96cm | 100Kg |



ref. **0806529**



**Cane
4-legs
Conical base**

| | | |
|---|---|---|
|  |  |  |
| 20x17cm | 73-96cm | 100Kg |



ref. **0807662**

**Cane
3-leg
Conical base**

| | | |
|--|---|---|
|  |  |  |
| 25x25x27cm | 73-96cm | 100Kg |



 ref. **0809771**



**Cane
4-leg Small base
Bariatric
Steel Frame**

| | | |
|---|---|---|
|  |  |  |
| 20x15cm | 76-99cm | 225Kg |



 ref. **0809772**

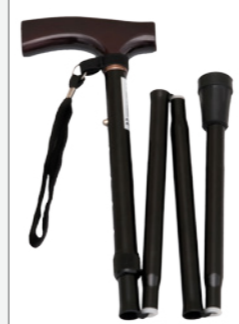

**Cane
4-leg Large base
Bariatric**

| | | |
|--|---|---|
|  |  |  |
| 30x21cm | 76-99cm | 225Kg |



ref. **0809256**



**Folding
Aluminium
Cane Black**

| | |
|---|---|
|  |  |
| 85-95cm | 100Kg |



ref. **0806523**



**Folding
Aluminium
Cane Bronze**

| | |
|---|---|
|  |  |
| 85-95cm | 100Kg |



ref. **0806520**

**Folding
Cane Bronze**

| | |
|---|---|
|  |  |
| 60-90cm | 100Kg |



ref. **0809246**



**Folding
Aluminium
Cane Black**

| | |
|---|---|
|  |  |
| 60-90cm | 100Kg |

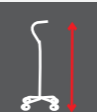

 ref. **0809377**

**Cane
Bariatric
Steel Frame**

| | |
|---|---|
|  |  |
| 73,7-96,6cm | 225Kg |



ref. **0810207** **Adjustable cane with Stand up Base & Led Flashlight**

- Black Colour
- Led Flashlight uses 2 X AA batteries (not included in the packaging)

| | | |
|-------|----------|-------|
| | | |
| 9x9cm | 80-100cm | 100Kg |



Stick
 • Height: 95cm
 • Colour: Chestnut

100kg ref. **0806177**



Stick
 • Height: 95cm
 • Colour: Chestnut (light)

100kg ref. **0806179**



Cane
 • Height: 95cm
 • Colour: Brown

100kg ref. **0809398**



Cane
 • Height: 95cm
 • Colour: Black
 • Imitation Horn Handle

100kg ref. **0806528**



Cane
 • Height: 95cm
 • Bamboo
 • Wooden handle

100kg ref. **0806180**



Cane
 • Height: 95cm
 • Colour: Black

100kg ref. **0809397**



Cane
 • Height: 95cm
 • Bamboo
 • Imitation Horn Handle

100kg ref. **0806524**

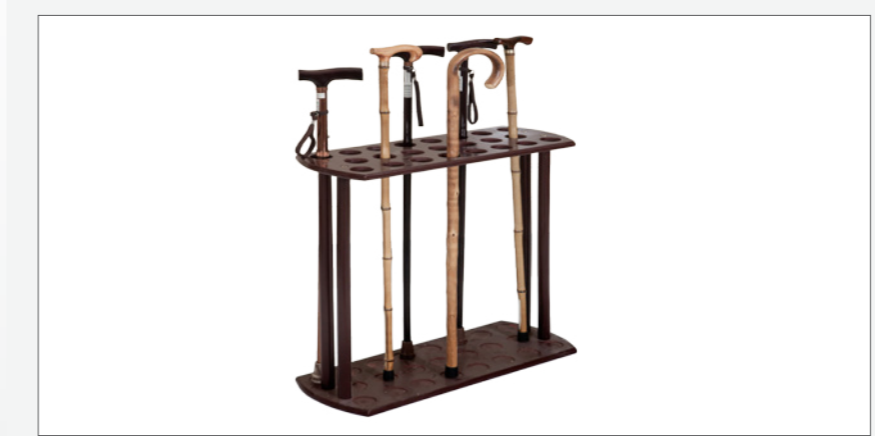

ref. **0807846**
Wooden Cane Case
 • Dimen. (LxWxH):61x23x65cm.
 • Holds 23 canes

Canes - Forearm Crutches

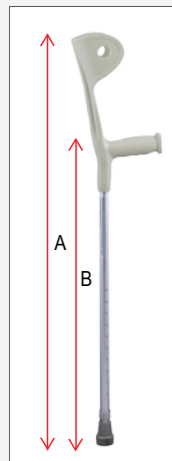

100kg ref. **0806531**

Forearm Crutch with Fixed handle

Adjustable Height (A)
96 to 119 cm
Adjustable Height (B)
76 to 99 cm

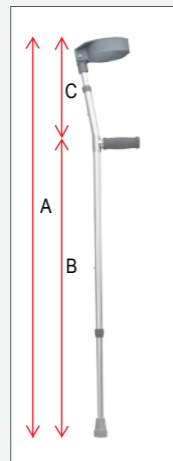

100kg ref. **0806104**

Forearm Crutch adjustable handle

Adjustable Height (A)
93 to 125 cm
Adjustable Height (B)
75 to 98 cm
Adjustable Height (C)
18 to 27 cm

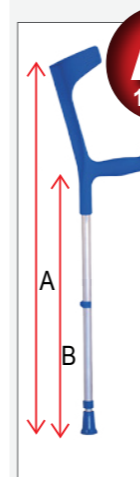

120kg ref. **0808466**

Forearm Crutch Reinforced with Fixed handle Blue

Adjustable Height (A) 87 to 120 cm
Adjustable Height (B) 66 to 95 cm

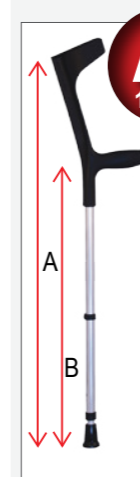

120kg ref. **0808467**

Forearm Crutch Reinforced with Fixed handle Black

Adjustable Height (A) 87 to 120 cm
Adjustable Height (B) 66 to 95 cm

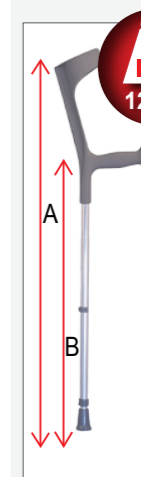

120kg ref. **0808468**

Forearm Crutch Reinforced with Fixed handle Grey

Adjustable Height (A) 87 to 120
Adjustable Height (B) 66 to 95 cm

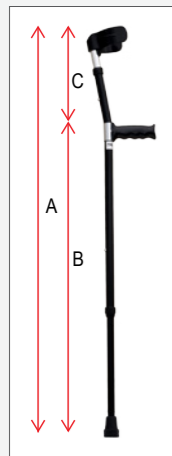

100kg ref. **0806530**

Forearm Crutch with adjustable handle Black

Adjustable Height (A)
86 to 117 cm
Adjustable Height (B)
66 to 89 cm
Adjustable Height (C)
20 to 28 cm

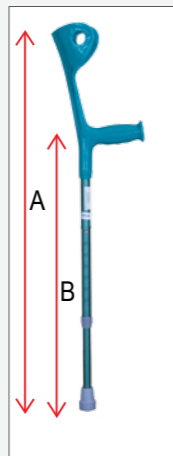

100kg ref. **0809783**

Forearm Crutch Coloured with fixed handle Blue

Adjustable Height (A)
96 to 119 cm
Adjustable Height (B)
76 to 95 cm

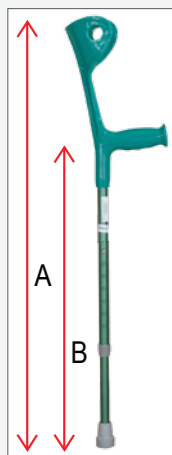

100kg ref. **0809782**

Forearm Crutch coloured with Fixed handle Green

Adjustable Height (A)
96 to 119 cm
Adjustable Height (B)
76 to 95 cm

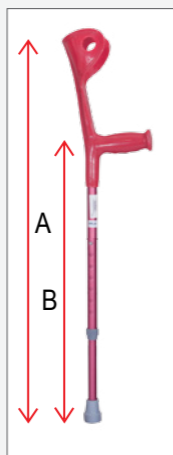

100kg ref. **0809781**

Forearm Crutch coloured with Fixed handle Magenta / Pink

Adjustable Height (A)
96 to 119 cm
Adjustable Height (B)
76 to 95 cm

Child Forearm Crutch Yellow - Red - Blue

110kg ref. **0808462**

Adjustable Height (A)
80 to 112 cm
Adjustable Height (B)
62 to 95 cm
With Reflector

110kg ref. **0808465**

Adjustable Height (A)
80 to 112 cm
Adjustable Height (B)
63 to 96 cm
With Reflector

110kg ref. **0806665**

Adjustable Height (A)
81 to 114 cm
Adjustable Height (B)
63 to 96 cm
With Reflector

Canes - Forearm Crutches



| | | |
|---|---|--|
| <p>ref. 0806103 100kg Underarm Crutch Simple Small - Yellow Height-adjustable</p> <p>94-114cm 100Kg</p> | <p>ref. 0806102 100kg Underarm Crutch Simple Medium - Yellow Height-adjustable</p> <p>114-134cm 100Kg</p> | <p>ref. 0806101 100kg Underarm Crutch Simple Large - Yellow Height-adjustable</p> <p>134-154cm 100Kg</p> |
|---|---|--|

| | |
|---|--|
| <p>ref. 0809770 100kg Underarm Crutch X Small - Grey Height-adjustable</p> <p>79-93cm 100Kg</p> | <p>ref. 0809776 100kg Underarm Crutch Small - Grey Height-adjustable</p> <p>93-113cm 100Kg</p> |
|---|--|

| | |
|--|---|
| <p>ref. 0809777 100kg Underarm Crutch Medium - Grey Height-adjustable</p> <p>113-133cm 100Kg</p> | <p>ref. 0809778 100kg Underarm Crutch Large - Grey Height-adjustable</p> <p>133-153cm 100Kg</p> |
|--|---|

| | | |
|--|---|--|
| <p>ref. 0810799 225kg Underarm Crutch Small Bariatric Steel Frame</p> <p>100-120cm 225Kg</p> | <p>ref. 0809767 225kg Underarm Crutch Medium Bariatric Steel Frame</p> <p>120-140cm 225Kg</p> | <p>ref. 0809768 225kg Underarm Crutch Large Bariatric Steel Frame</p> <p>140-160cm 225Kg</p> |
|--|---|--|

| | | | |
|--|---|---|--|
| <p>ref. 0807861 Rubber Tip Grey 1.3cm For Tripod and Quad Canes</p> | <p>ref. 0808495 Rubber Tip Black 1.3cm For Tripod and Quad Canes</p> | <p>ref. 0806444 Rubber Tip Black 1.6cm For wooden canes</p> | <p>ref. 0806445 Rubber Tip Black 1.8cm For wooden canes</p> |
| <p>ref. 0809363 Rubber Tip Black Medium 1.9cm For crutches & metal sticks</p> | <p>ref. 0808651 Rubber Tip Grey Medium 1.9cm For metal sticks</p> | <p>ref. 0808652 Rubber Tip Yellow Large 2.2cm For underarm crutches, crutches</p> | <p>ref. 0808677 Rubber Tip Black Large 2.2cm For underarm crutches, crutches</p> |
| <p>ref. 0809364 Rubber Tip Grey Large 2.2cm For underarm crutches, forearm crutches & metal sticks</p> | <p>ref. 0810599 Rubber Tip For Cane with Flashlight 0810207</p> | <p>ref. 0810582 Rubber Tip Grey 1.6cm Recommended for canes with code 0806529 & 0807662</p> | <p>ref. 0810583 Rubber Tip Black 1.6cm Recommended for canes: 0806510 & 0809667</p> |
| <p>ref. 0808079 Rubber Tip Grey 2.5cm Recommended for fixed toilet with code 0809176</p> | <p>ref. 0809553 Rubber Tip Grey 2.8cm For walkers</p> | <p>ref. 0808653 Rubber Tip Grey for Chair 2.8cm For bathtub chairs</p> | <p>ref. 0809552 Rubber Tip with suction cup Grey 2.8cm For bathtub chair with code 0810067</p> |
| <p>ref. 0810211 Rubber Tip Bariatric 2.22cm Recommended for cane with code 0809377</p> | <p>ref. 0810212 Rubber Tip Bariatric 1.3cm Recommended for canes with code 0809771- 0809772</p> | <p>ref. 0810213 Rubber Tip Bariatric 2.21cm For bariatric underarm crutches</p> | <p>κωδ. 0809362 Rubber Tip Wooden small 1,3cm For canes</p> |

| | |
|---|---|
| <p>ref. 0808645 Handle for Underarm Crutch Grey</p> | <p>ref. 0808213 Handle for Underarm Crutch Yellow</p> |
|---|---|

| | | |
|--|--|--|
| <p>ref. 0808646 Handle Underarm Crutch, hand, Grey</p> | <p>ref. 0808214 Handle for Underarm Crutch, hand, Yellow</p> | <p>ref. 0808777 Bench leg For bathtub bench cod. 0808366</p> |
|--|--|--|

Canes - Forearm Crutches

Orthopedic Products

Walker (Short, stable)



Short,
stable

| | |
|----------------|--------------------|
| ref. 0806941 | Boot S (25cm) |
| Small | (Shoe size: 36-39) |
| ref. 0806942 | Boot M (29cm) |
| Medium | (Shoe size: 40-43) |
| ref. 0806943 | Boot L (33cm) |
| Large | (Shoe size: 44-46) |
| ref. 0807684 | Boot XL (36cm) |
| X-Large | (Shoe size: 47+) |

Air Walker Tall



With air

| | |
|----------------|--------------------|
| ref. 0809097 | Boot S (25cm) |
| Small | (Shoe size: 36-39) |
| ref. 0809098 | Boot M (29cm) |
| Medium | (Shoe size: 40-43) |
| ref. 0809099 | Boot L (33cm) |
| Large | (Shoe size: 44-46) |
| ref. 0806803 | Boot XL (36cm) |
| X-Large | (Shoe size: 47+) |

Walker Tall



Tall,
stable

| | |
|----------------|--------------------|
| ref. 0809091 | Boot S (25cm) |
| Small | (Shoe size: 36-39) |
| ref. 0809092 | Boot M (29cm) |
| Medium | (Shoe size: 40-43) |
| ref. 0809093 | Boot L (33cm) |
| Large | (Shoe size: 44-46) |
| ref. 0808081 | Boot XL (36cm) |
| X-Large | (Shoe size: 47+) |

Orthopedic Products

ref. 0807669 Knee ROM Brace

Adjustable range 58.5 to 73 cm.



ref. 0807789 Ankle Air Cast Splint

One Size



ref. 0808306 Left Elbow ROM Brace

ref. 0808307 Right Elbow ROM Brace

• Adjustable range 34 to 43.5 cm.



ref. 0806935 Arm Sling



Socks Accessories

ref. 0810214 Sock Aid

New Product

Easy to use. Ideal for people with limited mobility or spine stiffness.



ref. 0810215 Shoe horn

New Product

• Plastic Black
• Length 43cm



Orthopedic
Products

The patented Universal XTW Extended Wear Collar powered by Boa Technology is a design featuring an adjustable dial powered by Boa Technology that allows collar height modification in order to fit most patients. Includes compliance ring to ensure patient protection. Reinforced thoracic frame for maximum support and comfort. Designed to help restrict flexion, extension, lateral bending and axial rotation. Shoulder, mandible and occipital contours for increased stability. Sheer finished, open cell liner is specifically designed to help prevent skin breakdown and provide sustained comfort during long term use. Latex-free

Applications

- Cervical Sprains and Strains
- Cervical Spinal Stenosis.
- Cervical Disc Displacement.
- Cervical Arthritis.
- Whiplash Injury.
- Cervical Spondylosis and Spondylolisthesis.
- Degenerative Disc Disease
- Cervicalgia

| | | |
|--------------|--|--------------------|
| ref. 0811200 | XTW BOA Height-adjustable Cervical Collar | New Product |
|--------------|--|--------------------|

One Size For A7 to A1

| | | |
|--------------|--|--------------------|
| ref. 0811201 | XTW BOA Height-adjustable Cervical Collar with extra PADS | New Product |
|--------------|--|--------------------|

One Size For A7 to A1

| | | |
|--------------|-------------------|--------------------|
| ref. 0811202 | Spare PADS | New Product |
|--------------|-------------------|--------------------|

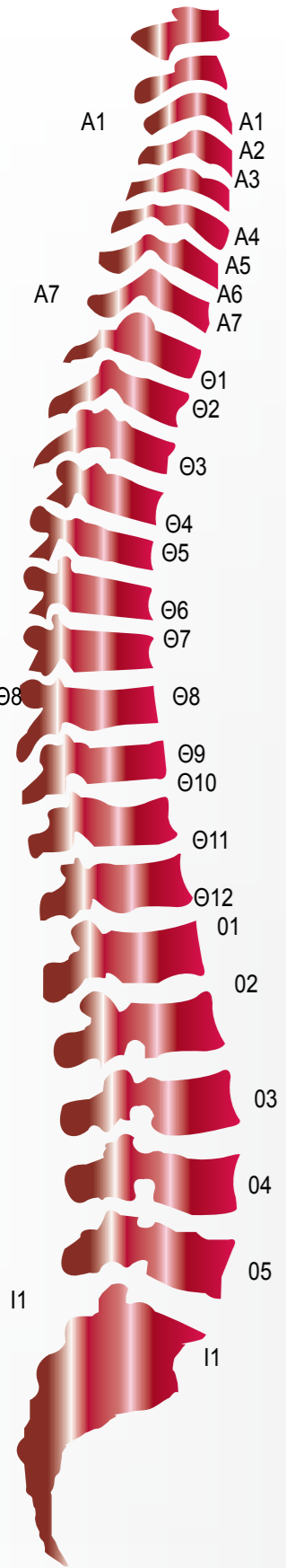

Cervical Thoracic Orthosis (CTO) provides anterior/posterior, medial/lateral support and rotational control for the upper thoracic and cervical spine. Latex-free, non-toxic, open-cell liner helps prevent skin breakdown and increase patient compliance. Easy to adjust for a comfortable secure fit. Various sizes available, including pediatric (upon request).

Applications

- Stable Cervical Fractures and Dislocations
- Stable High Thoracic Fractures and Dislocations
- Cervical Sprains and Strains.
- Post-operative Stabilization of the Upper Spine.
- Rheumatoid Arthritis.
- Cervical Spondylosis.

| | | |
|--------------|---|--------------------|
| ref. 0811203 | Cervical Thoracic Orthosis CTO Short | New Product |
|--------------|---|--------------------|

For Θ2 to A1

| | | |
|--------------|---|--------------------|
| ref. 0811204 | Cervical Thoracic Orthosis CTO Regular | New Product |
|--------------|---|--------------------|

For Θ2 to A1

| | | |
|--------------|--|--------------------|
| ref. 0811205 | Cervical Thoracic Orthosis CTO Tall | New Product |
|--------------|--|--------------------|

For Θ2 to A1



www.mobiacare.gr

WARRIOR SERIES

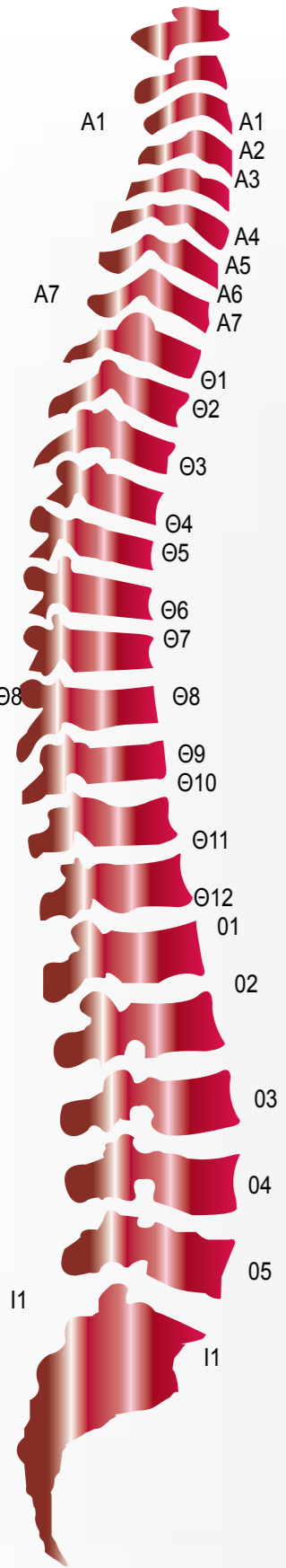

Warrior™ Universal Orthoses are One Size, for a 61cm to 152.4cm range, ideal for all applications.
 Patent pending, single pull bi-lateral sizing adjustment.
 Powered by Boa® Technology for a powerful and secure closure that is easy for the patient to tighten with the turn of a dial.
 Enlarged Boa® dials allow micro-adjustability and on-the-fly compression and adjustment with fewer turns.
 Integrated anterior panels and closure hand strap for easy donning and doffing.
 Soft breathable material to provide a cool, comfortable fit.
 Rounded anterior closure to accommodate varying patient anatomies (inferior and superior angulation).
 Hot temperature Gel packs included with each packing.

Applications

- Post-operative lumbar fusion
- Post-operative lumbar immobilization
- Laminectomy or discectomy
- Lumbar compression fractures
- Degenerative disc disease
- Osteoporosis
- Spinal stenosis
- Single column instability immobilization
- Lumbar strains and sprains
- Mechanical or discogenic disc disease
- Postural support
- Spondylolisthesis
- Spondylolysis

ref. **0811207** **Warrior Lumbar Spinal Orthosis (LSO)** **New Product**
One Size • For O5 to O1
 • For 61 to 152.4 cm



ref. **0811208** **Warrior Lumbar Spinal Orthosis (LSO)** **New Product**
One Size • For O1 to O9
 • For 61 to 152.4 cm



ref. **0811209** **Warrior Lumbar Spinal Orthosis LSO & extra side panels** **New Product**
One Size • For O1 to O9
 • For 61 to 152.4 cm



*What is Boa® Technology?

Boa® is a revolutionary, direct-on-the-spot- delivery system that is easy for both the patient and the treating doctor. A perfect closure system with the turn of a dial.

PROlign® features extended posterior panel for coverage from sacrococcygeal junction to the L1 vertebrae. Powered by Boa® Technology for a powerful and secure closure that is easy for the patient to tighten with the turn of a dial.
 Enlarged Boa® dials allow micro-adjustability and on-the-fly compression and adjustment with fewer turns. Rigid anterior insert provides support to the intra-abdominal and viscera region helping to unload the spine under gravitational load.
 Posterior plastic inserts to help maintain neutral sagittal alignment while maximizing support of anatomical structures.
 Soft breathable material to provide a cool, comfortable fit
 Patented dual closure for infinite adjustability.

Applications

- Post-operative lumbar immobilization
- Chronic low back pain
- Lumbar muscle weakness
- Lumbar strains and sprains
- Mechanical or discogenic disc disease
- Postural support
- Degenerative disc disease
- Intradiscal Electrothermal Annuloplasty procedure

ref. **0811210** **Prolign Lumbar Spinal Orthosis (LSO) Small** **New Product**
Small • For O5 to O1
 • For 76.2 to 87 cm

ref. **0811211** **Prolign Lumbar Spinal Orthosis (LSO) Medium** **New Product**
Medium • For O5 to O1
 • For 88 to 101.6 cm

ref. **0811212** **Prolign Lumbar Spinal Orthosis (LSO) Large** **New Product**
Large • For O5 to O1
 • For 101.6 to 116.84 cm

ref. **0811213** **Prolign Lumbar Spinal Orthosis (LSO) X-Large** **New Product**
X-Large • For O5 to O1
 • For 114.3 to 127 cm



*What is Boa® Technology?

Boa® is a revolutionary, direct-on-the-spot- delivery system that is easy for both the patient and the treating doctor. A perfect closure system with the turn of a dial.

Orthoses

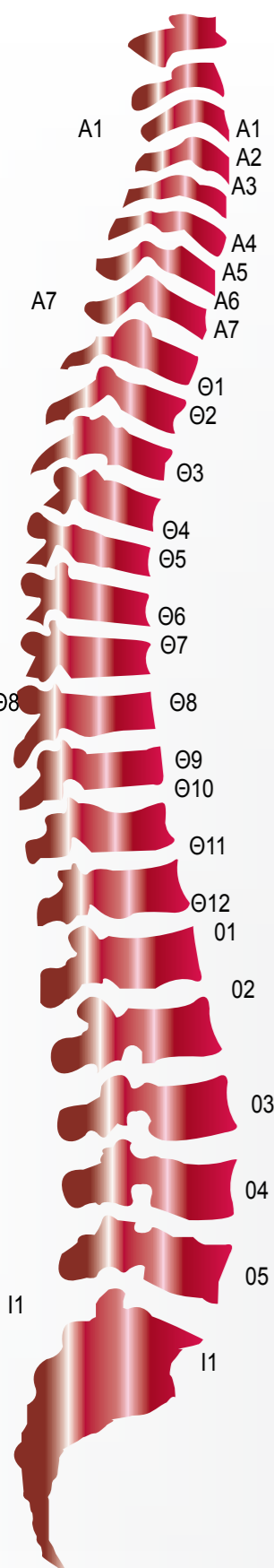

PROlign® EXT features extended posterior panel for coverage from sacrococcygeal junction to the T9 vertebrae.
 Rigid anterior insert provides support to the intra-abdominal and viscera region helping to unload the spine under gravitational load.
 Soft breathable material to provide a cool, comfortable fit
 Patented dual closure for infinite adjustability.
 Posterior plastic inserts to help maintain neutral sagittal alignment while maximizing support of anatomical structures.
 Powered by Boa® Technology for a powerful and secure closure that is easy for the patient to tighten with the turn of a dial.
 Enlarged Boa® dials allow micro-adjustability and on-the-fly compression.

Applications

- Post-operative lumbar immobilization
- Chronic low back pain
- Lumbar muscle weakness
- Lumbar strains and sprains

| | | |
|--------------|------------------------------|--------------------|
| ref. 0811214 | PROlign EXT LSO Small | New Product |
|--------------|------------------------------|--------------------|

- Small**
- For O1 to O9
 - For 76.2 to 87 cm

| | | |
|--------------|-------------------------------|--------------------|
| ref. 0811215 | PROlign EXT LSO Medium | New Product |
|--------------|-------------------------------|--------------------|

- Medium**
- For O1 to O9
 - For 88 to 101.6 cm

| | | |
|--------------|------------------------------|--------------------|
| ref. 0811216 | PROlign EXT LSO Large | New Product |
|--------------|------------------------------|--------------------|

- Large**
- For O1 to O9
 - For 101.6 to 116.84 cm

| | | |
|--------------|--------------------------------|--------------------|
| ref. 0811217 | PROlign EXT LSO X-Large | New Product |
|--------------|--------------------------------|--------------------|

- X-Large**
- For O1 to O9
 - For 114.3 to 127 cm



*What is Boa® Technology?

Boa® is a revolutionary, direct-on-the-spot- delivery system that is easy for both the patient and the treating doctor. A perfect closure system with the turn of a dial.

Ultralign+® Series offers exceptional comfort and functionality in a soft, lightweight, wearable spinal orthosis. Up to 60% lighter than comparable models, the Ultralign®+ is comprised of removable polymer inserts covered by cool, breathable open cell material with an inner liner that draws moisture away from the skin. Provides hydrostatic lift and instant relief to the spine through a superior, more therapeutic precision fit which easily adjusts to fit most patients comfortably.
 Constructed of hook receivable material with soft, breathable liner that provides a cooler, lighter fit.
 Combines anterior, posterior and lateral plastic inserts for rigid support.
 Enlarged Boa® dials allow micro-adjustability and on-the-fly compression.
 2- Size Extension panels available for XXL size extension in bariatric patients (upon request).
 Powered by Boa® Technology for a powerful and secure closure that is easy for the patient to tighten with the turn of a dial.

Applications

- Post-operative thoracic/lumbar fusion
- Laminectomy or discectomy.
- Compression fractures.
- Degenerative disc disease.
- Osteoporosis.
- Spondylolisthesis, Spondylolysis or Spinal stenosis.
- Cervical and Lumbar Osteoarthritis.

| | | |
|--------------|----------------------------|--------------------|
| ref. 0811218 | Ultralign LSO Small | New Product |
|--------------|----------------------------|--------------------|

- Small**
- For O1 to O9
 - Waist Circumference from 78,74 to 88,9cm

| | | |
|--------------|-----------------------------|--------------------|
| ref. 0811219 | Ultralign LSO Medium | New Product |
|--------------|-----------------------------|--------------------|

- Medium**
- For O1 to O9
 - Waist Circumference from 81,28 to 96,52cm

| | | |
|--------------|----------------------------|--------------------|
| ref. 0811220 | Ultralign LSO Large | New Product |
|--------------|----------------------------|--------------------|

- Large**
- For O1 to O9
 - Waist Circumference from 88,90 to 104,14cm

| | | |
|--------------|------------------------------|--------------------|
| ref. 0811221 | Ultralign LSO X-Large | New Product |
|--------------|------------------------------|--------------------|

- X-Large**
- For O1 to O9
 - Waist Circumference from 96,52 to 114,30cm



*What is Boa® Technology?

Boa® is a revolutionary, direct-on-the-spot- delivery system that is easy for both the patient and the treating doctor. A perfect closure system with the turn of a dial.



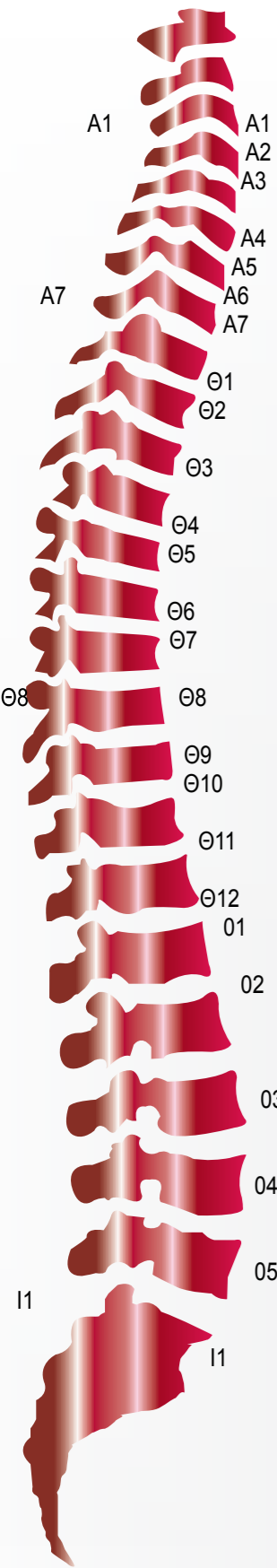

Ultralign+®Series offers exceptional comfort and functionality in a soft, lightweight, wearable spinal orthosis. Up to 60% lighter than comparable models, the Ultralign+®Series is comprised of removable polymer inserts covered by cool, breathable open cell material with an inner liner that draws moisture away from the skin.

Provides hydrostatic lift and instant relief to the spine through a superior, more therapeutic precision fit which easily adjusts to fit most patients comfortably.

Dorsal Lumbar Extension and various sternal kit pads (including Noble Hinge™) available for superior control and precise fit (Optional).

Constructed of hook receivable material with soft, breathable liner that provides a cooler, lighter fit.

Combines anterior, posterior and lateral plastic inserts for rigid support.

2- Size Extension panels available for XXL size extension in bariatric patients (upon request).

Powered by Boa® Technology for a powerful and secure closure that is easy for the patient to tighten with the turn of a dial.

Enlarged Boa® dials allow micro-adjustability and on-the-fly compression.

Applications

- Post-operative thoracic/lumbar fusion.
- Laminectomy or discectomy.
- Compression fractures.
- Degenerative disc disease.
- Osteoporosis.
- Spondylolisthesis, Spondylolysis or Spinal stenosis.
- Cervical and Lumbar Osteoarthritis.
- Single column thoracic immobilization.

ref. 0811222 **Ultralign TLSO Small** **New Product**

- Small**
- For O1 to Θ6
 - Waist Circumference from 78,74 to 88,9cm

ref. 0811223 **Ultralign TLSO Medium** **New Product**

- Medium**
- For O1 to Θ6
 - Waist Circumference from 81,28 to 96,52cm

ref. 0811224 **Ultralign TLSO Large** **New Product**

- Large**
- For O1 to Θ6
 - Waist Circumference from 88,90 to 104,14cm

ref. 0811225 **Ultralign TLSO X-Large** **New Product**

- X-Large**
- For O1 to Θ6
 - Waist Circumference from 96,52 to 114,30cm



When greater stabilization or immobilization are required, the following accessories can be used:

ref. 0811226 **Sternal Pad Kit (Universal SPK)** **New Product**

One Size



ref. 0811227 **Sternal Pad Kit Adjustable (SPK-Noble Hinge)** **New Product**

One Size



What is Noble Hinge™?

Noble Hinge™ Technology is a unique and innovative combination of high quality, lightweight hardware built into a flexible panel. This creates a formable frame that can capture the unique shape of an individual's anatomy and, when locked into place, creates a rigid foundation of support. No changes in metal parts.

ref. 0811228 **Dorsal Lumbar Extension (DLE)** **New Product**

One Size



Orthoses



κωδ. 0806512 **Static Bike**

- Homecare use
- Upper & Lower Limb exercises
- Difficulty level adjustment
- 1-year warranty



ref. 0807423 **Active/Passive Exercise Cycle**

- 15-20 minutes of use equals 30 minutes of exercise
- Complete upper and lower limb exercise
- Offers a complete workout for the hands and feet
- Product Materials: Plastic ABS / Steel
- Electricity: 220V-13W 0.13A
- Usage time: 5-30 minutes
- Turns: 6-60 per minute
- Automatic shutdown after 1 hour of continuous use
- Immobilizer boot ref. 0807425 (Optional)
- Warranty 1 year



ref. 0807424 **Active/Passive Exercise Cycle**

- Integrated exercise at the top and bottom simultaneously.
- Product Materials: Stainless and Ergonomic, Gray with Polyurethane Pad
- Electricity: 220V - 50W 0.13A
- Time 1 - 30 minutes
- Turns: 18 - 80 per minute
- Automatic shutdown after 1 hour of continuous use
- Immobilizer boot ref. 0807425 (Optional)
- Warranty 1 year

Accessory:

ref. 0807425 **Immobilizer pedal (boot)**

- Immobilizer pedal (boot)
- For bicycle 0807423, 0807424
- Optional accessory





Exercise Stretch Bands

New Product

Resistance Tube Features:

- Exercise Stretch Bands are an affordable solution to exercise the upper and lower limbs.
- It is a lightweight, compact and high-strength aid.
- They are effective when used alone or with other accessories.
- Used in clinics for rehabilitation, preparation and training since 1987, and in many physiotherapy applications.
- Packaged in dispensing box.
- Desired length can be unrolled and cut using scissors.
- Low content powder made from natural rubber latex.
- Available according to exercise band resistance in 8 colors for progressive exercise
- Levels vary with the strength, from minimum to maximum: light yellow, yellow, red, green, blue, black, silver, gold.

| | |
|--|---|
| ref. 0811400 • 5,5m roll Light Yellow 2x - Soft | ref. 0811408 • 45,5m roll Light Yellow 2x - Soft |
| ref. 0811401 • 5,5m roll Yellow 1x - Soft | ref. 0811409 • 45,5m roll Yellow 1x - Soft |
| ref. 0811402 • 5,5m roll Red Soft | ref. 0811410 • 45,5m roll Red Soft |
| ref. 0811403 • 5,5m roll Green Medium | ref. 0811411 • 45,5m roll Green Medium |
| ref. 0811404 • 5,5m roll Blue Hard | ref. 0811412 • 45,5m roll Blue Hard |
| ref. 0811405 • 5,5m roll Black 1x - Hard | ref. 0811413 • 45,5m roll Black 1x - Hard |
| ref. 0811406 • 5,5m roll Silver 2x - Hard | ref. 0811414 • 23m roll Silver 2x - Hard |
| ref. 0811407 • 5,5m roll Gold 3x - Hard | ref. 0811415 • 23m roll Gold 3x - Hard |

Resistance Scale

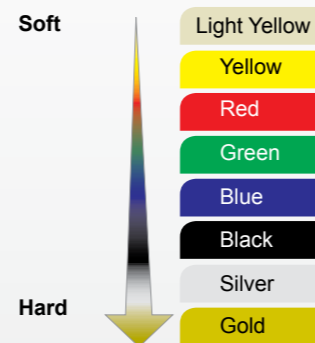

Resistance Tube

New Product

Resistance Tube Features:

- Resistance Tubes are an affordable solution to exercise the upper and lower limbs.
- It is a lightweight, compact and high-strength aid.
- They are effective when used alone or with other accessories.
- High-quality resistance tubes are used in clinics for rehabilitation, preparation and training since 1987, and in many physiotherapy applications.
- Packaged in dispensing box.
- Desired length can be unrolled and cut using scissors.
- Low content powder made from natural rubber latex.
- Available according to exercise band resistance in 6 colors for progressive exercise
- Levels vary with the strength, from minimum to maximum: red, green, blue, black, silver, gold.

| | |
|--|---|
| ref. 0811416 • 7,6m roll Red Soft | ref. 0811422 • 30,5m roll Red Soft |
| ref. 0811417 • 7,6m roll Green Medium | ref. 0811423 • 30,5m roll Green Medium |
| ref. 0811418 • 7,6m roll Blue Hard | ref. 0811424 • 30,5m roll Blue Hard |
| ref. 0811419 • 7,6m roll Black 1x - Hard | ref. 0811425 • 30,5m roll Black 1x - Hard |
| ref. 0811420 • 7,6m roll Silver 2x - Hard | ref. 0811426 • 30,5m roll Silver 2x - Hard |
| ref. 0811421 • 7,6m roll Gold 3x - Hard | ref. 0811427 • 30,5m roll Gold 3x - Hard |

Resistance Scale

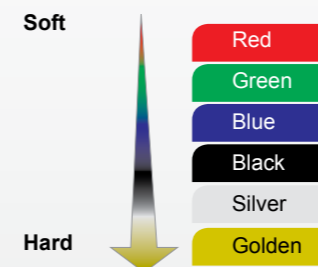

Rehabilitation-Physiotherapy



Resistance Tube With Padded Cuffs

New Product



Features of Resistance Tube with padded cuffs:

- Lightweight, compact and portable, helps to strengthen and work out.
- Two ankle / wrist pads.
- It is pre-mounted with a 90cm perimeter.
- Low content powder made from natural rubber latex.
- Length represents the length of the tube from end to end when the module is placed on a flat surface.
- Levels vary with the strength, from minimum to maximum resistance: yellow, red, green, blue, black.

| | | |
|--|--|---|
| ref. 0811428 • 45 cm Yellow 1x - Soft | ref. 0811430 • 45 cm Green Medium | ref. 0811431 • 45 cm Blue Hard |
| ref. 0811429 • 45 cm Red Soft | | ref. 0811432 • 45 cm Black 1x - Hard |

BowTie™ Resistance Tube

New Product



BowTie Resistance Tube Features:

- Lightweight, compact and portable, helps to strengthen and work out.
- Two fixed rigid foam-coated handles offer comfort and stability.
- Low content powder, made from natural rubber latex.
- Length represents the length of the tube from end to end when the module is placed on a flat surface.
- Levels vary with the strength, from minimum to maximum: red, green, blue, black.

| | | |
|---|---|--|
| ref. 0811433 • 36cm Red Soft | ref. 0811434 • 36cm Green Medium | ref. 0811435 • 36cm Blue Hard |
| | | ref. 0811436 • 36cm Black 1x - Hard |

Resistance Tube With Handles

New Product

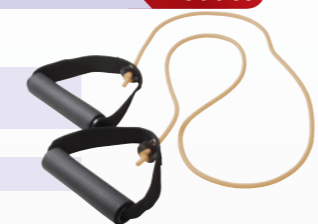

Features of Resistance Tube with Handles:

- Lightweight, compact and portable Resistance Tube with Handles, helps to strengthen and work out.
- Two fixed rigid foam-coated handles offer comfort and stability.
- Low content powder made from natural rubber latex.
- Length represents the length of the tube from end to end when the module is placed on a flat surface.
- Levels vary with the strength, from minimum to maximum: yellow, red, green, blue, black.

| | | |
|--|--|---|
| ref. 0811437 • 120cm Yellow 1x - Soft | ref. 0811439 • 120cm Green Medium | ref. 0811440 • 120cm Blue Hard |
| ref. 0811438 • 120cm Red Soft | | ref. 0811441 • 120cm Black 1x - Hard |

Resistance Scale



ref. **0811442**

Accessories – Handle with D-Ring

New Product

- Packing: 1 pair

Handle features:

- The handle may be used with the bands and resistance tubes with a double knot around the D-ring.
- Each handle has an inner rigid tube which is covered with foam for greater comfort.
- Accessory is sold separately from Bands & Tubes.



ref. **0811443**

Accessories – Handle with Foam coating

New Product

- Packing: 1 pair

Handle features:

- The handle can be used with the bands and resistance tubes, by inserting them through the handle.
- Each handle has an inner rigid tube and is covered with foam for greater comfort.
- Accessory is sold separately from Bands & Tubes.



ref. **0811444**

Accessory – Door Hook Strap

New Product

Strap Features:

- The Door Anchoring Strap is used at the point where the door is closed.
- Place the Strap on the door opening at any height point.
- Close the door to create your own home Gym!
- High-resistance straps make this accessory extremely durable.
- Accessory is sold separately from Bands & Tubes.



ref. **0811445**

Accessory – Door Anchoring Strap with Hook

New Product

Strap Features:

- The Door Anchoring Strap with Hook is equipped with a built-in pulley, it can be used above the door, under the door or at the point where the door is closed.
- Accessory is sold separately from Bands & Tubes.



Rehabilitation-Physiotherapy



Loop Band Resistance Band

Νέο
Προϊόν

Loop Band Features:

- High quality latex exercise band pre-formed into a loop.
- Loops are ready-to-use, you do not have to cut and tie it!
- Long Loops have special size for upper body exercises.

| | |
|--|--|
| ref. 0811446 • 25cm Length Yellow 1x - Soft | ref. 0811453 • 76cm Length Yellow 1x - Soft |
| ref. 0811447 • 25cm Length Red Soft | ref. 0811454 • 76cm Length Red Soft |
| ref. 0811448 • 25cm Length Green Medium | ref. 0811455 • 76cm Length Green Medium |
| ref. 0811449 • 25cm Length Blue Hard | ref. 0811456 • 76cm Length Blue Hard |
| ref. 0811450 • 25cm Length Black 1x - Hard | ref. 0811457 • 76cm Length Black 1x - Hard |
| ref. 0811451 • 25cm Length Silver 2x - Hard | ref. 0811458 • 76cm Length Silver 2x - Hard |
| ref. 0811452 • 25cm Length Gold 3x - Hard | ref. 0811459 • 76cm Length Gold 3x - Hard |

Resistance Scale

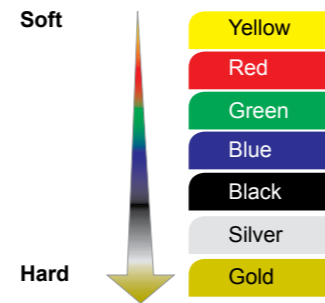

Digi-Flex® Hand Exerciser

New
Product

DigiFlex Features:

- Digi-Flex® hand exercise develops finger strength, flexibility and coordination as it builds hand and forearm strength.
- Use each button independently to exercise fingers or compress the entire unit for complete hand and forearm strengthening.
- Develops isolated finger strength, flexibility, and coordination.
- Progressive color-coded resistance gives patient positive feedback.

| | |
|---|--|
| ref. 0811460 • Light Yellow 2x - Soft - Finger (340 g) / Hand (1.1 kg) | ref. 0811464 • Blue Hard - Finger (3.2 kg) / Hand (10.4 kg) |
| ref. 0811461 • Yellow 1x - Soft - Finger (680 g) / Hand (2.3 kg) | ref. 0811465 • Black 1x - Hard - Finger (4.1 kg) / Hand (14.1 kg) |
| ref. 0811462 • Red Soft - Finger (1.4 kg) / Hand (4.54 kg) | ref. 0811466 • 5-position plastic stand |
| ref. 0811463 • Green Medium - Finger (2.3 kg) / Hand (7.26 kg) | |

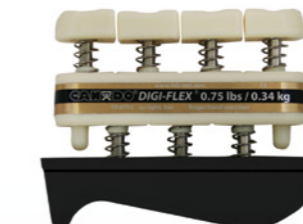
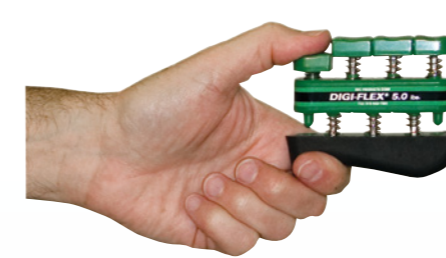

Resistance Scale

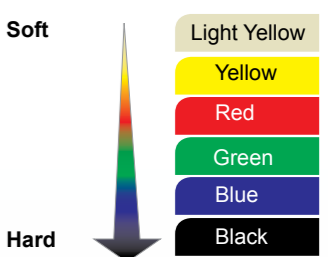

ErgoGrip Hand Grip Exerciser

New
Product

ErgoGrip Features:

- Ergonomic ErgoGrip Hand Exerciser is sold in pairs.
- Weight (in Kg) equals the amount of force needed to fully compress the fixed ErgoGrip handles.
- Resistance sequence on these ergonomic grips covers any needs from the earliest stages of rehabilitation after stroke (yellow) to advanced athletic training (black).
- The force equivalent doubles with each level so you can work your way up.

| |
|--|
| ref. 0811467 • Yellow 1x - Soft - 1,4kg |
| ref. 0811468 • Red Soft - 2,7kg |
| ref. 0811469 • Green Medium - 5,4kg |
| ref. 0811470 • Blue Hard - 11kg |
| ref. 0811471 • Black 1x - Hard - 22kg |

Resistance Scale

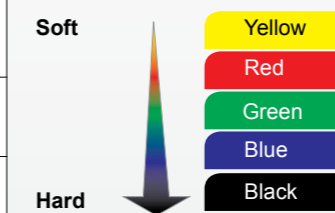

Rehabilitation-Physiotherapy



Theraputty® Exercise Putty

New Product

Exercise Putty Features:

- Theraputty® hand exercise material is the standard in resistive hand exercise material.
- Each color-coded putty has a different consistency ranging from xx-soft for strengthening the weakest grasp to extra-firm for developing a stronger grip.
- Available in convenient plastic containers to use at home, hospital or clinic.
- Theraputty® material is gluten, latex and casein free.

| | |
|--|---|
| ref. 0811472 • 84 gr Light Yellow 2x - Soft | ref. 0811475 • 84 gr Green Medium |
| ref. 0811473 • 84 gr Yellow 1x - Soft | ref. 0811476 • 84 gr Blue Hard |
| ref. 0811474 • 84 gr Red Soft | ref. 0811477 • 84 gr Black 1x - Hard |



Resistance Scale

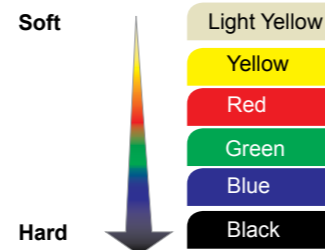

Web Hand Exerciser

New Product

Web Hand Exerciser Features:

- Used in hand therapy for flexion, extension, opposition, and supination exercises.
- Resistance may be modified by adjusting the hand position, depth of finger insertion, or by moving to a different resistance (color) web.
- Available in 35-cm diameter size in low-powder and no-latex formulation

| | |
|--|--|
| ref. 0811478 • Diameter 35cm - Multi-Resistance, Yellow Green | ref. 0811479 • Diameter 35cm - Multi-Resistance, Red Blue |
|--|--|

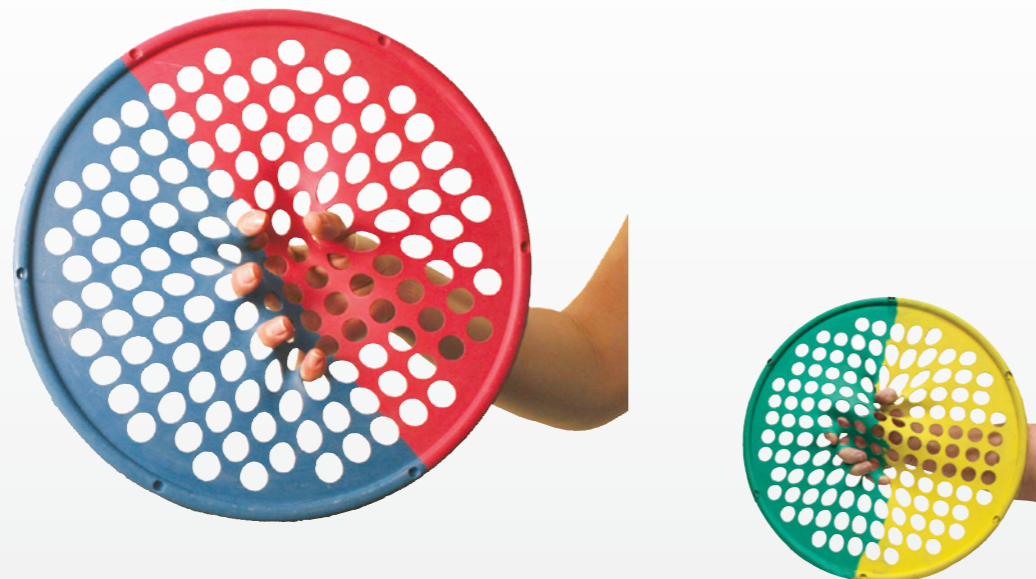

Handweb™ Extension Hand Exerciser

New Product

Hand Web Extension Hand Exerciser Features:

- Ideal for tennis elbow.
- Use to strengthen digit and forearm extensors, for intrinsic hand strengthening exercises, muscle re-education for thumbs, and to restore dynamic thumb stabilization.
- Exercisers are available in 5 progressive color-coded levels of resistance.
- From lightest to heaviest: yellow, red, green, blue and black.
- It can be used with the exercise balls.

| | | |
|--|--|---|
| ref. 0811480 • Yellow 1x - Soft | ref. 0811482 • Green Medium | ref. 0811484 • Black 1x Hard |
| ref. 0811481 • Red Soft | ref. 0811483 • Blue Hard | |

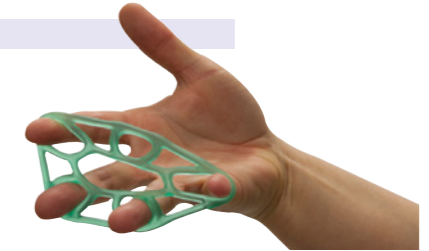

Resistance Scale



Gel Squeeze Ball

New Product

Gel Squeeze Ball Features:

- Hand exerciser for grip strength, dexterity, mobility, and fine and gross motor skills.
- It can be heated or chilled for hot and cold therapy.
- Available according to exercise band resistance in 6 colors for progressive exercise
- Each level (stability) is available in ball- or egg-shapes.
- Balls can withstand temperatures ranging from -60°C to 75°C.

| | |
|--|---|
| ref. 0811485 • Light yellow 2x - Soft | ref. 0811488 • Green Medium |
| ref. 0811486 • Yellow 1x - Soft | ref. 0811489 • Blue Hard |
| ref. 0811487 • Red Soft | ref. 0811490 • Black 1x - Hard |



Squeeze Egg Gel

New Product

Squeeze Egg Gel Features:

- Hand exerciser for grip strength, dexterity, mobility, and fine and gross motor skills.
- It can be heated or chilled for hot and cold therapy.
- Available according to exercise band resistance in 6 colors for progressive exercise
- Each level (stability) is available in ball- or egg-shapes.
- Balls can withstand temperatures ranging from -60° to 75°C.

| | |
|--|---|
| ref. 0811491 • Light Yellow 2x - Soft | ref. 0811494 • Green Medium |
| ref. 0811492 • Yellow 1x - Soft | ref. 0811495 • Blue Hard |
| ref. 0811493 • Red Soft | ref. 0811496 • Black 1x - Hard |



Resistance Scale

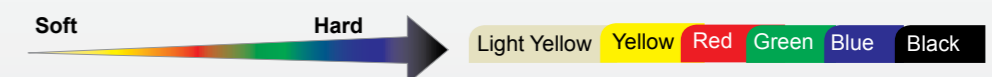



ref. 0808878

Examination Bed-Reinforced New Product

| | |
|------------------------|-----------------------------|
| Dimensions | (M) 190 x (Π) 60cm |
| Height | 70cm |
| Head rest Dimensions | (M) 66 x (Π) 60cm |
| Head rest inclination | 15°, 27°, 36°, 41° |
| Maximum Patient Weight | 200Kg |
| Bed Weight | 32.5Kg |
| Packing Dimensions | (L) 193 x (D) 62 x (H) 13cm |

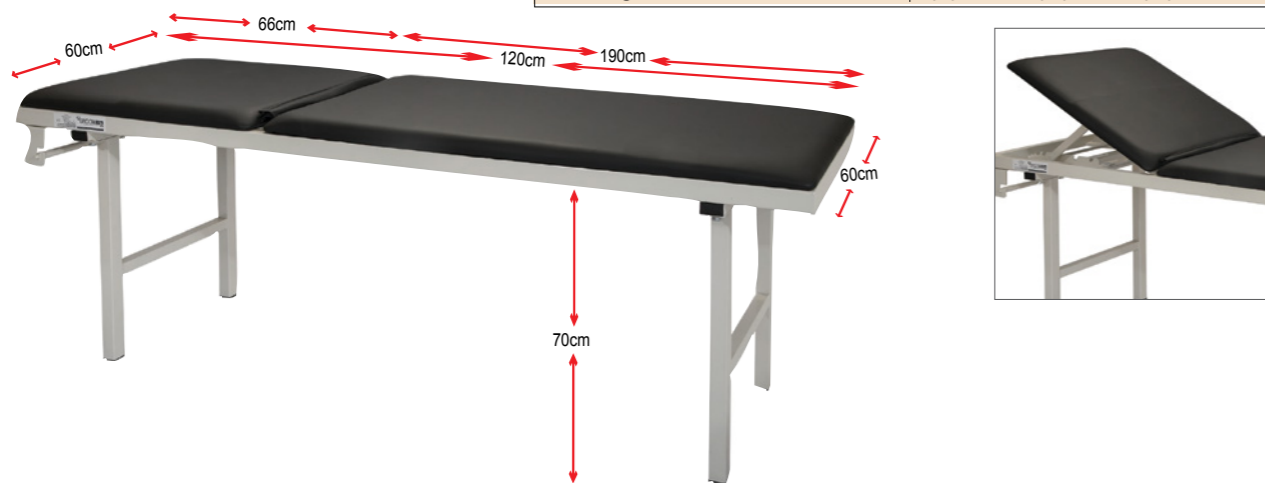

ref. 0806421

Electrical Examination Bed Deluxe New Product

- Head rest dimensions (LxW): 63x70cm
- Head rest adjustment: Hydraulic
- Motor Power 50 watts

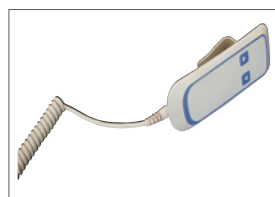

Package includes:

- Paper holder
- Hand Control device
- Keg control device

| Dimen. (LxWxH) (LxW) | Headrest inclination | Bed Weight | Pack. Weight (LxWxH) | Adjustable Height |
|-----------------------------|----------------------|------------|--------------------------------|------------------------------|
| ref. 0806421 195 x 70 cm | up to 63 degrees | 56,5 kg | 198 x 72 x 25cm MB: 59,5 Kg | Electrical 56cm to 93,5cm |



ref. 0808877

Examination Bed-Folding New Product

- Additional length with head rest 30cm
- Additional width with side armrests 21cm
- Dimensions (closed): 92.5x60x20 cm



| | |
|--|-------------------|
| Dimensions | (L)185 x (W) 60cm |
| Additional length with head rest 30cm | 30cm |
| Adjustable head rest | 0-45° |
| Additional width with side armrests 21cm | 21cm |
| Adjustable Height | 60 to 85cm |
| Maximum Patient Weight | 150Kg |
| Product Weight | 12,20Kg |



Package includes:

- External headrest
- Side armrests
- Front armrest
- Carrying bag





ref. **0808876** **Leather Chair Black** **New Product**

- Dimensions [Folded] (LxWxH): 71x63x58cm
- Dimensions [Not Folded] (LxWxH): 190x63x90cm
- Packing Dimensions (LxWxH): 81.5x65.5x59cm
- Weight: 22.5Kg
- Max. Load: 150Kg
- Gross weight: 25.8Kg



ref. **0809253** **Single step** **New Product**

- Steel Frame
- Plastic mat with black rubber anti-slip surface.
- Max. Load: 113 Kg



ref. **0806371** **Double Step -Reinforced**

- Steel Frame
- Max. Load: 100 Kg



ref. **0806467** **Textile Ward Screen-Light Blue**

ref. **0808236** **Textile Ward Screen-White**

- 3 Panels
- Dimensions (WxH): 60x175cm / Panel

ref. **0806633** **X-ray Film Viewer Single**

- Ext. Dimensions (HxWxW): 43.5x 51.5x 10.5 cm
- Inter. Dimensions (HxW): 35x 43 cm
- Light T8/765.15W.44cm



ref. **0223014** **X-ray Film Viewer Double**

- Ext. Dimensions (HxWxW): 92x 51.5x 10.5 cm
- Inter. Dimensions (HxW): 84x43 cm
- Light T8/765.30W,90cm



ref. **0806372** **X-ray Film Viewer Triple**

- Ext. Dimensions (HxWxW): 122x 51.5x 10.5 cm
- Inter. Dimensions (HxW): 114 x 43 cm
- Light T8/765.36W,120cm



ref. **0223012** Portable Defibrillator **New Product**

Mandatory in all public and crowded places based on the European Regulations



- Automatic external defibrillator designed for providing simple and direct voice prompts and indications for a straightforward rescue operation.
- Lightweight and battery powered for maximum portability.
- Designed to treat Ventricular Fibrillation (VF) and Fast Ventricular Tachycardia (VT).
- WAVEFORM: e-cube biphasic (Truncated exponential type); impedance compensated
- ENERGY: 200J according to AHA Standard Guidelines 2010.
- Adult: nominal 200J into a 50 ohm load.
- Infant/child: lower than 50 J with light pediatric pads (optional)
- CHARGE TIME BEFORE "SHOCK ADVISED": < 8 seconds, typically with a new battery.
- INSTRUCTION FOR USE: detailed voice instructions for use in the Greek Language defibrillator users.
- BATTERY: 12 Volt DC, 4.2 Ah, lithium manganese dioxide, long-life primary cell
- BATTERY CAPACITY: Min. 200 Shocks or 4 hours of operating time.
- AUTOMATIC CONTROLS AND USER-ACTIVATED CONTROLS
- DATA RECORDING AND TRANSMISSION
- SIZE: 80x300x270 mm
- WEIGHT: 2.2 kg with battery installed
- Standard package includes:
Device unit, a set of disposable adult pads (cod. 0808679), a battery.
- Optional: E set of disposable infant/child pads (cod. 0808742).
- Device Warranty: 5 years (disposable PADS bear no warranty, however the shelf life is 2 years).
- Battery Warranty (cod. 0808661): 5 years (prior to the opening of the compartment), 4 years (after opened and placed). (Each package has an expiration date)

ref. **0808679** Adult Defibrillator PADS **New Product**



ref. **0808742** Pediatric Defibrillator PADS **New Product**



Car First Aid Kits

- First Aid Kits include: Adhesive Pads, Gauzes, Alcohol Pads, Bandages, Adhesive Tape, Single Use Gloves & Pair of Scissors.



ref. **0145047** Small

ref. **0145048** Medium

ref. **0145049** Big

- Dimensions (LxWxH): 18.5x13.5x4.5cm

- Extra: Dry Ice Pad, Forceps, CPR Mask
- Dimensions (LxWxH): 23x16x4.5cm.

- Extra: Isotherm Blanket, Forceps, CPR Mask
- Dimensions (LxWxH): 23x15x6cm



The Research and Development (R&D) Department of MOBIAK guarantees to keep on its steady course in order to continue providing you with the best quality products & services, having a philosophy always a step ahead.

The MOBIAK R&D Team cooperates strongly with the Manufacture and the Marketing Sectors in order to be more and more innovative and pioneering in the products it creates, their design, their style and the offered services that accompany them. By developing new products, it is plotted a new path - an unprecedented knowledge - a revolutionary technology.

MOBIAK R&D Projects do not intend to immediate profit, they represent, entirely growing procedure and investment, which involves a lot of dedication and a profound research.

Being one of the most crucial sectors for MOBIAK, R&D Department ensures that products are competitive and innovative. Its strong commitment is naturally grown by the members of the group, consisting of numerous Special Product Designers, such as Electrical Engineers, Engineers of various specialties, Chemists, etc. Their purpose is to ensure that each product meets all regulations, legal requirements, the highest standards in quality control and the needs of MOBIAK's present and future partners.

We commit that we will keep offering you the best solutions the Medical Equipment field for every demand!



- Copying and reproduction of MOBIAK products without permission from the recipient company is prohibited.
- The Catalogue you have in your hands invalidates previous catalogues.
- MOBIAK reserves the right to change product specifications without prior notice.
- We are not responsible for any printing errors
- Product dimensions may be deviated in a range of ± 2 cm



The products might be modified.
Please be informed about the current models either by visiting MOBIAKCARE's website
www.mobiakcare.gr
or by contacting the Sales Department at
mobiakcareexports@mobiak.gr
(Tel: +30 28210 63222)



website



phn



youtube



*Value in safety..
Invest in Quality !*

