

THE KEY TO SUCCESS!



MOBIAK[®]
FIREFIGHTING • GASES • MEDICAL est. 1977
www.mobiak.com

Value in safety...

Invest in Quality!



arts of Fire Extinguishers &
Fire Suppression Systems



CONTACT DETAILS

FACTORY - HEAD QUARTERS:

Akrotiri, Chania, Crete, Greece P.C. 73100

Tel. **+30 28210 63222**

Fax **FIREFIGHTING DEPT.: +30 28210 66260**

Fax **MOBIAKCARE: +30 28210 66403**

Fax **LIQUID & GAS DEPT.: +30 28210 66405**

e-mail: exports1@mobiak.com, exports@mobiak.com

PYROMEDICAL Ltd:

96 - 98 Markou Botsari Str.

Chania, Crete, Greece P.C. 73136

Tel.: **+30 28210 91561 / +30 28210 91661**

Fax: **+30 28210 91644**

Installations & Fire Protection Studies

PYROPROSTASIA Ltd:

20 Anapafseos Str. Chania

Chania, Crete, Greece P.C. 73100

Tel.: **+30 28210 72445**

DISTRIBUTION CENTERS

Central, South & Isn. Greece:

Sxineza, Aspropirgos, Attica, Greece P.C. 19300

Tel.: **+30 210 4614006, +30 210 5593004**

Fax: **+30 210 5595986**

Distribution Center North Greece & Balkan Area:

8 Arkadiou Str. Kalochori, Thessaloniki, Greece

P.C. 57009

Tel.: **+30 2310 785668, +30 2310 778477**

Fax: **+30 2310 574793**

Distribution Center Central & Eastern Crete:

P' Str. Industrial Zone of Heraklion, Crete, Greece

P.C. 71601

Tel. / Fax: **+30 2810 333151**

www.mobiak.com



arts of Fire Extinguishers &
Fire Suppression Systems

Parts of Fire Extinguishers & Fire Suppression Systems

6

FIRE EXTINGUISHER CYLINDERS

12

CYLINDERS

14

METALLIC CAP, SAFETY - CARRYING HANDLE, PROTECTIVE VALVE'S COVERS, PROTECTIVE VALVE'S DISC, ALUMINUM CYLINDER

15

VALVES FOR FIRE EXTINGUISHERS AND FIRE SUPPRESSION SYSTEMS

24

BRAZEN TAP

25

SOLENOID VALVES, ODORIZER, PRESSURE REGULATOR, ALMOND ODORIZER

26

FUSES, SAFETY PINS

28

SAFETY SEALS, INSPECTION RINGS

30

SPARE KIT FOR VALVE, O - RING

31

FOAM GENERATOR, NOZZLES, SPARE STRING

32

GAUGES

35

FIRE EXTINGUISHER HOSES

40

SPARE PARTS, O - RING FOR DISCHARGE HOSES

41

HEAVY DUTY HORN, PLASTIC BELTS, SQUEEZE LEVEL, PLASTIC FOAM GENERATOR FOR SQUEEZE LEVEL HOSE

42

PLASTIC FOOT FOR FIRE EXTINGUISHERS

43

SPARE CO₂ INTERNAL CARTRIDGE FOR FIRE EXTINGUISHERS

44

FIRE EXTINGUISHER DIP TUBES, FILTERS

47

FOAM FILTERS

48

CAST BRAZEN UNIONS

49

BALL VALVE, CAST BRAZEN UNION, AIR CHARGING VALVE, THREAD GLUE

50

FLEXIBLE HOSES, NOZZLES

51

NOZZLES

index

52

THERMO LINKS,
90° METAL WIRE GUIDE ROLL,
STAINLESS STEEL WIRE,
STAINLESS STEEL WIRE CLAMP

53

PARTS OF SYSTEMS

54

SPECIAL TYPE SPRINKLERS,
PARTS OF SYSTEMS

56

SMOKE DETECTORS

58

INSTRUCTION SIGNS

60

SPRINKLER

68

PROTECTIVE COVER,
ROSETTE, MANIFOLD TEE

69

MANIFOLD PIPE,
MANIFOLD CAP

70

MANIFOLD REDUCING
COUPLING, NON RETURN
VALVE, FLEXIBLE HOSES

71

COUPLINGS,
FLEXIBLE HOSE,
WASHERS

72

WEIGHTING
DEVICES

75

FIRE
EXTINGUISHERS
BRACKETS

76

MAGNETIC
BRACKET FOR
FIRE EXTINGUISHERS

77

PLASTIC FIRE
EXTINGUISHER BRACKETS

78

WALL MOUNTED
BRACKETS, METALLIC RINGS

79

BRACKET ADAPTORS,
SECURITY ALARM

80

FLOOR TYPE STANDS

82

BRACKETS FOR
CYLINDERS AND FIRE
EXTINGUISHERS

84

BRACKET AND TEE
CONNECTOR, FIRE
EXTINGUISHER SUPPORT BELT

86

PROTECTICE BOX FOR
FIRE EXTINGUISHERS

90

NAYLON COVER, PVC
COVER, POLYESTER BOXES

92

TROLLEY FOR
FIRE EXTINGUISHERS

FIRE EXTINGUISHER CYLINDERS

DRY POWDER & CLEAN AGENT

One Seam Dry Powder Vessel with M30x1,5mm Neck Thread.

One Seam Dry Powder Vessel with M74x2mm Neck Thread

(for Internal Cartridge extinguishers).

PT 26bar, PS 18bar



CODE 0116014

FT01 - 501 - A4

1Kg

D: 85mm ±1, H: 270mm ±2mm



CODE 0116016

FT01 - 502 - A4

2Kg

D: 110mm ±1, H: 310mm ±5mm



CODE 0116017

FT01 - 504 - A4

3Kg

D: 130mm ±1, H: 365mm ±5mm



CODE 0116015

FT01 - 06A - 02 - 00

6Kg

D: 160mm ±1,5, H: 450mm ±5mm



CODE 0116021

MBK13 - VESSEL - 9

9Kg

D: 180mm ±1,5, H: 510mm ±5mm



CODE 0116018

FT01 - 12A - 02 - 00

12Kg

D: 190mm ±1,5, H: 535mm ±5mm



CODE 0116024

MBK14 - VESSEL6KG - CARTR

6Kg

D: 160mm ±1,5, H: 455mm ±5mm
FOR FIRE EXTINGUISHERS WITH INTERNAL
CARTRIDGE AND ALUMINUM VALVE



CODE 0116025

MBK14 - VESSEL9KG - CARTR

9Kg

D: 180mm ±1,5, H: 515mm ±5mm
FOR FIRE EXTINGUISHERS WITH INTERNAL
CARTRIDGE AND ALUMINUM VALVE



CLEAN AGENT

CODE 0116033

MBK19-CYLINDER - 3FE

3Kg

D: 130mm ±1, H: 365mm ±5mm

Cylinder for Fire Extinguisher

MBK18-030HFC-P1A

PS 24,5bar

PT 35bar



CLEAN AGENT

CODE 0116032

MBK19-CYLINDER - 6FE

6Kg

D: 160mm ±1,5, H: 450mm ±1,5mm

Cylinder for Fire Extinguisher

MBK18-060HFC-P1A

PS 24,5bar

PT 35bar





SPARE PARTS FOR FIRE EXTINGUISHERS AND FIRE SUPPRESSION SYSTEMS

FIRE EXTINGUISHER CYLINDERS

FOAM-WATER-ABF-WET CHEMICAL - WATER MIST

One Seam Vessel with Internal Plastic Layer for Maximum Anti - Oxidation Protection, with **M30x1,5mm** Neck Tread.

One Seam Vessel with Internal Plastic Layer with **M74x2mm** Neck Tread (for Internal Cartridge extinguishers).

PT 27bar, PS 18bar

CYLINDER
WITH
INTERNAL
PLASTIC
COATING

CE



Exclusive!



CODE 0116013

MBK15 - 501 - A3

1Lt
D: 85mm ±1, H: 270mm ±2mm



CODE 0116011

MBK15 - 502 - A3

2Lt
D: 110mm ±1, H: 310mm ±5mm



CODE 0116012

MBK15 - 504 - A3

3Lt
D: 130mm ±1, H: 365mm ±5mm



CODE 0116007

MBK13 - VESSEL - PL - 6

6Lt
D: 160mm ±1,5, H: 470mm ±5mm



CODE 0116008

MBK13 - VESSEL - PL - 9

9Lt
D: 180mm ±1,5, H: 525mm ±5mm



CODE 0119193

MBK14 - FOAM6LT - CARTR

6Lt
D: 160mm ±1.5mm, H: 470mm ±5mm
FOR FIRE EXTINGUISHERS WITH INTERNAL
CARTRIDGE AND ALUMINUM VALVE
PS 20BAR, PT 30BAR



CODE 0119194

MBK14 - FOAM9LT - CARTR

9Lt
D: 180mm ±1.5mm, H: 530mm ±5mm
FOR FIRE EXTINGUISHERS WITH INTERNAL
CARTRIDGE AND ALUMINUM VALVE
PS 20BAR, PT 30BAR

CODE 0119195

MBK14 - ABF6LT - CARTR

6Lt
D: 160mm ±1.5mm, H: 470mm ±5mm
FOR FIRE EXTINGUISHERS WITH INTERNAL
CARTRIDGE AND BRASS VALVE
PS 20BAR, PT 30BAR

CODE 0119196

MBK14 - ABF9LT - CARTR

9Lt
D: 180mm ±1.5mm, H: 530mm ±5mm
FOR FIRE EXTINGUISHERS WITH INTERNAL
CARTRIDGE AND BRASS VALVE
PS 20BAR, PT 30BAR

FIRE EXTINGUISHER CYLINDERS

STAINLESS STEEL

One Seam Stainless Steel **CYLINDERS**
with M30x1, 5mm Neck Thread.

PT 26bar, PS 18bar INOX



CODE 0137011

MBK15 - 501 - B2

1Kg / 1Lt

D: 89mm ±0,5, H: 250mm ±2mm



CODE 0137059

MBK15 - 502 - B3

2Kg / 2Lt

D: 110mm ±0,5, H: 302mm ±2mm



CODE 0137057

MBK15 - 504 - B2

3Kg / 3Lt

D: 130mm ±1, H: 346mm ±2mm



CODE 0137060

MBK15 - 507 - B3

6Kg / 6Lt

D: 160mm ±1, H: 448mm ±3mm



CODE 0137012

MBK13 - VESSEL - SS - 12

12Kg / 9Lt

D: 180mm ±1, H: 595mm ±3mm

PT 30bar, PS 20bar



SPARE PARTS FOR FIRE EXTINGUISHERS AND FIRE SUPPRESSION SYSTEMS

FIRE EXTINGUISHER CYLINDERS

CEILING

Cylindrical Type Vessel for Ceiling Extinguisher **with Conical HOOP**. Separate Bracket with Bolt and Nut. **M30x1,5mm Neck Thread**.

PT 26BAR, PS 18BAR



CONICAL HOOP. WITH BIG DIAMETER (160MM) FOR EASY INSTALLATION



CODE 0135113

MBK15 - ACE6 - A2R

6Kg

H: 446mm ±5mm
D: 213mm ±1,5mm

The Only Ceiling Extinguisher CYLINDER of TP 26bar and 1,87mm Thickness, offering Maximum Safety



CODE 0137056

MBK07 - ACE12 - A3

12Kg

H: 431mm ±5mm
D: 320mm ±1,5mm

The Only Ceiling Extinguisher CYLINDER of TP 26bar and 2,5mm Thickness, offering Maximum Safety



CONICAL HOOP with aligned holes for overall discharge of suppressing agent, easier gauge control and also for easy fire extinguisher refilling



CEILING BRACKET with bolt and nut for quick and easy installation

FIRE EXTINGUISHER CYLINDERS

LOCAL APPLICATION

Local Application Fire Extinguisher CYLINDER. with **Separate** Wall Bracket with **Carrying / Installation Handles** and extra **Cross-Support AT BOTTOM** for Safer Installation.

ABLE TO INSTALL IN Column.

1" Neck Thread BSP (BS En ISO 228-1).

TP 40bar and PS 28bar, WITH thickness 2,3mm and 2,72mm for the 25Kg and 50Kg Fire Extinguisher respectively.

Soft Material is Used in the Retaining Wreaths of the Vessel to Avoid Injuries and Oxidation

CYLINDER WITH INTERNAL PLASTIC COATING

CYLINDER WITH INTERNAL PLASTIC COATING

CYLINDER WITH INTERNAL PLASTIC COATING

CODE 0116019

MBK13 - VESSEL - PL - 19.5

19.5Lt Foam / ABF - Wet Chemical
 D: 190mm, H: 795 ± 2mm



CODE 0137040

MBK13 - VESSEL - 25

25Kg Dry powder
 D: 270 ± 2,5mm, H: 627,5 ± 5mm



CODE 0137058

MBK13 - VESSEL - PL - 25

25Lt Foam / ABF - Wet Chemical
 D: 270 ± 2,5mm, H: 627,5 ± 5mm



CODE 0137066

MBK15 - PES50 - A2

50Kg Dry powder
 D: 320 ± 3mm, H: 875 ± 5mm



CODE 0137055

MBK13 - VESSEL - PL - 50

50Lt Foam / ABF - Wet Chemical
 D: 320 ± 3mm, H: 875 ± 5mm





SPARE PARTS FOR FIRE EXTINGUISHERS AND FIRE SUPPRESSION SYSTEMS

FIRE EXTINGUISHER CYLINDERS

DRY POWDER TROLLEYS

Dry Powder Fire Extinguisher Trolley Cylinder with **Separate Carriage**.

Cylinder Neck, **D: 50mm** with Male Thread, **heavy duty wheels**.



Soft Material is Used in the Retaining Wreaths of the Vessel to Avoid Injuries and Oxidation

Addition of 3rd Wheel on the Front Side of the Carriage for Easy Use - Transportation

CODE 0137038

MBK15 - 525 - A2

25Kg

PT 27bar, PS 18bar

CE CYLINDER

CODE 0137039

MBK15 - 528 - A2

50Kg

PT 27bar, PS 18bar

CE CYLINDER

FIRE EXTINGUISHER CYLINDERS

FOAM - WATER TROLLEYS

FOAM - WATER Fire Extinguisher Trolley Cylinder with **Separate Carriage**.

Cylinder Neck, **D: 50mm** with Male Thread, **Heavy Duty Wheels**.



CYLINDER WITH INTERNAL PLASTIC COATING

CODE 0137054

MBK15 - 525 - A2R

25Ll

PT 27bar, PS 18bar

CE CYLINDER

CODE 0137051

MBK15 - 528 - A2R

50Ll

PT 27bar, PS 18bar

CE CYLINDER

CODE 0137062

MBK10 - 1000AF - A2

100Ll

PT 27bar, PS 18bar

CE CYLINDER

HIGH PRESSURE CYLINDERS

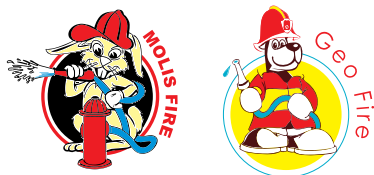

OPTION FOR **FILLING**
OF CYLINDERS
 WITH FIRE SUPPRESSION
 EXTINGUISHING
 GAS AGENTS AND **USE**
OF CERTIFIED

CODE 0128010

KX11 - 532 - B2

3 Lt
 CAPACITY: 3 Lt
 D: Ø116 mm ± 1,16mm,
 H: 385 mm ± 10mm.
 WP 200bar
 PT 300bar
 2010/35/EU (π)
 EN 1964-1



CODE 0128017

MBK06 - ST - 12

16 Lt
 CAPACITY: 16 Lt
 D: 200 mm ±2mm, H: 960mm.
 WP 200bar
 PT 300bar
 EN 1964 - 1/ISO 9809 - 1
 2010/35/EU (π)

CODE 0128018

MBK06 - ST - 30

40 Lt
 CAPACITY: 40 Lt
 D: 229 mm ±2,29mm, H: 1500mm.
 WP 200bar
 PT 300bar
 EN 1964 - 1/ISO 9809 - 1
 2010/35/EU (π)

CODE 0128019

MBK06 - ST - 35

50 Lt
 CAPACITY: 50 Lt
 D: 229 mm ±2,29mm, H: 1485mm.
 WP 200bar
 PT 300bar
 EN 1964 - 1/ISO 9809 - 1
 2010/35/EU (π)





SPARE PARTS FOR FIRE EXTINGUISHERS AND FIRE SUPPRESSION SYSTEMS

HIGH PRESSURE CYLINDERS

FILLING OF CYLINDERS
WITH SUPPRESSION
EXTINGUISHING
GAS AGENTS AND USAGE
OF CERTIFIED
VALVES AVAILABLE
UPON REQUEST



CODE 0128043

MBK09 - TIC - 45

68 Lt

Volume: 67,5 Lt

D: 267mm \pm 2,67mm, H: 1500mm.

WP 150bar

PT 250bar

ISO 9809 - 1

2010/35/EU (π)

CODE 0128033

MBK08 - ZW - 50

68 Lt

Volume: 68 Lt

D: 267mm \pm 2,67mm, H: 1500mm.

WP 200bar

PT 300bar

EN 1964 - 1/ISO 9809 - 1

2010/35/EU (π)

CODE 0128045

MBK12 - TIC - 50

75 Lt

Volume: 75 Lt,

D: 267mm \pm 2,67mm, H: 1640mm.

WP 150bar

PT 250bar

EN 1964 - 1/ISO 9809 - 1

2010/35/EU (π)

CODE 0128025

MBK06 - ST - 60

80 Lt

Volume: 80 Lt

D: 267mm \pm 2,67mm, H: 1740mm.

WP 200bar

PT 300bar

EN 1964 - 1/ISO 9809 - 1

2010/35/EU (π)

SPARE PARTS FOR FIRE EXTINGUISHERS AND FIRE SUPPRESSION SYSTEMS

SAFETY CAP



CODE 0216024

KX10 - 026 - 01

Safety Cap for Gas Cylinder Valve

SAFETY - CARRYING HANDLE

Plastic Carrying Handle for Gas Cylinder with External Neck Thread.
 Also used on Trolley CO₂ Fire Extinguishers for Valve Protection



CODE 0134001

KX10 - 166 - 00

VALVE PROTECTION CAP

Plastic Protection Cap for the protection of CO₂ Fire Extinguisher's valve.
 Used for Protection in Case of Fall.



CODE 0119136

KX10 - 346 - 00

2Kg CO₂



CODE 0119135

KX10 - 346A - 00

5Kg CO₂

VALVE SAFETY DISC

Protecting the Cylinder Valve in case of fall.
 Also, it is Recommended for Lifting Fire Suppression CO₂ / IG541 / IG55 Systems Cylinders from Basements, Ships Engine Rooms, etc.



CODE 0134007

KX10 - 181 - 00

ALUMINUM CYLINDERS

NECK THREAD

WP 200bar, PT 300bar, EN 1975, 2010/35/EU (π), ADR

CODE 0201032

KX11 - 531 - D2 - NECK

2Ll
 D: 111 ±0,8325mm, H: 360 ±3.6mm

CODE 0201033

KX11 - 532 - D2 - NECK

3Ll
 D: 111 ±0,8325mm, H: 495 ±4,95mm

CODE 0201031

KX11 - 536 - D2 - NECK

5Ll
 D: 140mm ±1.05mm, H: 525mm ±5.25mm





SPARE PARTS FOR FIRE EXTINGUISHERS AND FIRE SUPPRESSION SYSTEMS

VALVES

NICKEL PLATED FIRE EXTINGUISHER'S AND FIRE SUPPRESSION SYSTEMS' VALVES



CODE 0119400



MBK19 - VALVE - MED

Suitable for Fire Extinguisher Code
MBK12 - MEDFIRE

PS 18bar (60°C), PT 27bar

CE (TUV)



CODE 0119023

KX02 - 015J - 00

6Kg / 9Kg / 12Kg & 6Lt / 9Lt

Dry Powder / Foam /ABF-Wet Chemical / Water
Squeeze - grip Valve with Inlet M30x1,5mm, Outlet G1/4".
Pressure Gauge Safety Release Mechanism and Plastic
Nipple to adjust the Dip Tube.

Gauge Thread M10x1mm.

PS 18bar (60°C), PT 27bar

CE (TUV)



CODE 0119399



MBK19-CA-VALVE-GR

6Kg

CLEAN AGENT Fire Extinguisher Valve with Inlet
M30x1,5mm, Outlet G1/4"
and plastic Nipple to adjust the Dip Tube.

Gauge Thread M10x1mm.

PS 35bar (60°C), PT 51bar

CE (TUV)



CODE 0119398



MBK19-CA-VALVE-3

3Kg

Suitable for the **MBK18 - 030HFC - P1A**
Fire Extinguisher

PS 35bar (60°C), PT 51bar

CE (TUV)



CODE 0119021

KX02 - 017H - 00/CE2

3Kg / 3Lt

Dry Powder / Foam /ABF-Wet Chemical / Water
Squeeze - grip Valve with Inlet M30x1,5mm, Outlet
G1/4", **Medium Size. Pressure Gauge Safety Release**
Mechanism and Plastic Nipple to Adjust the Dip
Tube.

Gauge Thread M10x1mm.

PS 18bar (60°C), PT 27bar

CE (TUV)

VALVES

NICKEL PLATED FIRE EXTINGUISHER'S AND FIRE SUPPRESSION SYSTEMS' VALVES



CODE 0119026

KX01 - 009F - 00/CE1

1Kg / 2Kg & 1Lt / 2Lt

Dry Powder / Foam / ABF-Wet Chemical / Water
 Squeeze - grip Valve with Inlet M30x1,5mm,
 Outlet G 1/8". **Pressure Gauge Safety Release
 Mechanism** and plastic **Nipple to Adjust the Dip
 Tube.**

Gauge Thread M10x1mm.
PS 18bar (60°C), PT 27bar

CE (TUV)



CODE 0119091

KX01 - 004 - 00C

1Kg / 2Kg / 3Kg & 1Lt / 2Lt / 3Lt

Dry Powder / Foam / Water
 Squeeze - grip Valve with Inlet M24x1,5mm.
Pressure Gauge Safety Release Mechanism.

Gauge Thread M10x1mm.
PS18bar(60°C), PT 26bar



CODE 0119092

KX01 - 006A - 00B

6Kg / 12Kg & 6Lt / 9Lt

Dry Powder / Foam / Water
 Squeeze - grip Valve with Inlet M24x1,5mm.
Pressure Gauge Safety Release Mechanism

Gauge Thread M10x1mm.



CODE 0119175

MBK13 - VALVE - CARTR

6Kg / 9Kg / 12Kg & 6Lt / 9Lt

Valve for Dry Powder / Foam / Water
 Cartridge Operated Fire Extinguishers

Valve Inlet M74X2 mm
Valve Outlet M16X1,5mm
PS 18bar (60°C), PT 27bar

CE (TUV)



SPARE PARTS FOR FIRE EXTINGUISHERS AND FIRE SUPPRESSION SYSTEMS

VALVES

NICKEL PLATED FIRE EXTINGUISHER'S AND FIRE SUPPRESSION SYSTEMS' VALVES



CODE 0119177

MBK13 - ALU - VALVE - Y - CARTR

6Kg / 9Kg

Aluminum Valve with Knob and Female Threaded Coupling for **Dry Powder** Fire Extinguishers with Internal Cartridge. With Pressure Indicator. With Brazen Nipple to Adjust the Dip Tube.

Inlet Thread M74x2 mm
Outlet Thread M18x1,5mm
Dip Tube Thread M18x1,5mm
PS 18bar (60°C), PT 27bar

CE (TUV)



CODE 0119197

MBK13 - ALU - VALVE - G - CARTR

6Lt / 9Lt

Aluminum Valve with Knob and Female Threaded Coupling for **Foam** Fire Extinguishers with Internal Cartridge. With Pressure Indicator.

Inlet Thread M74x2 mm
Outlet Thread M18x1,5mm
Dip Tube Thread M16x1,5mm
PS 18bar (60°C), PT 27bar

CE (TUV)



CODE 0119388

MBK19 - ALU - VALVE - BLK - CARTR

6Kg / 9Kg & 6Lt / 9Lt

Black Aluminum Valve with Knob and Female Coupling for Fire Extinguishers with Internal Cartridge. With Pressure Indicator.

Inlet Thread M74x2 mm
Outlet Thread M18x1,5mm
Dip Tube Thread M16x1,5mm
PS 18bar (60°C), PT 27bar



NEW



CODE 0119198

MBK13 - BVALVE - CARTR

6Lt / 9Lt

Brass Valve with Knob and Female Threaded Coupling for **ABF-Wet Chemical** Fire Extinguishers with Internal Cartridge. With Pressure Indicator.

Inlet Thread M74x2 mm
Outlet Thread M18x1,5mm
Dip Tube Thread M16x1,5mm
PS 18bar (60°C), PT 27bar

CE (TUV)

VALVES

FIRE EXTINGUISHER'S AND FIRE SUPPRESSION SYSTEMS' VALVES



CODE 0119014

KX02 - 025G(RE.1) - 00/CE1

3Kg / 6Kg / 12Kg & 3Lt / 6Lt / 9Lt INOX
 Stainless Steel Dry Powder / Foam / Water /
 ABF - Wet Chemical
 Squeeze - Grip Valve.
Inlet Thread M30 x1,5mm
Gauge Thread M10x1mm
Outlet G1/4"
 With Brazen Nipple to adjust the Dip Tube
PS 18bar, PT 26bar

CE (TUV)



CODE 0119125

KX01 - 009F - 00A1

1Kg / 2Kg & 1Lt / 2Lt
 Stainless Steel Dry Powder / Foam / Water /
 ABF - Wet Chemical
 Squeeze - Grip Valve.
Inlet Thread M30 x1,5mm with Pressure Gauge
Safety Release Mechanism
Gauge Thread M10x1mm
Outlet G1/8"
 With Plastic Nipple to Adjust the Dip Tube
PS 18bar, PT 26bar

CE (TUV)



CODE 0119110

KX05 - 003C - 00/CE

25Kg / 50Kg / 100Kg & 25Lt / 50Lt / 100Lt
 Nickel Plated Valve for Dry Powder / Foam /
 Water Trolley Fire Extinguisher.
 With Female Threaded Coupling and **Pressure**
Gauge Safety Release Mechanism.
Gauge Thread M10x1mm
Inlet G2"-11(Φ500mm), Outlet G3/4"-14
PS 26bar, PT 42bar

CE (TUV)



SPARE PARTS FOR FIRE EXTINGUISHERS AND FIRE SUPPRESSION SYSTEMS

VALVES

FIRE EXTINGUISHER'S AND FIRE SUPPRESSION SYSTEMS' VALVES



CODE 0119100

MBK13 - 280VALVE - 30X1.5

6Kg / 9Kg / 12kg & 6Lt - 16Lt
Gauge Thread M10x1mm
Outlet Thread W21,8x1/14 (M22x1,5)
Inlet Thread M30x1,5mm

Valve with Safety Bursting Disc
for Dry Powder / ABF - Wet Chemical / Foam / Water Fire Suppression Systems.
Manually or Fuse Activated.
With Adaptor for Fuse.
Fuse (MBK02-PYR) not Included.
PS 20bar, PT 39bar

CE (TUV)



CODE 0119098

KX05 - 002C - 00

Valve for Dry Powder / Foam / Water Trolley Fire Extinguisher.

Gauge Thread M10x1
Inlet G1", Outlet G½"



CODE 0119124

KX05 - 004 - 44C

Spare Handle for Valve of Trolley Fire Extinguisher

CODE 0119104

MBK13 - 280VALVE - 1

25Kg / 50kg & 17Lt - 35Lt
Manometer thread M10X1mm
Outlet thread W21.8X1/14 (M22X1.5)
Outlet thread G1-11"

Valve with Safety Bursting Disc
for Dry Powder / ABF - Wet Chemical / Foam / Water Fire Suppression Systems.
Manually or Fuse Activated.
With Adaptor for Fuse.
Fuse (MBK02-PYR) not Included.
PS 30bar, PT 54bar

CE (TUV)



CODE 0119221



MBK16 - ILP - 30X1.5

Automatic Pneumatic Valve (Indirect, ILP) for Wet Chemical Kitchen Fire Suppression Systems
Gauge and Pressure Relief Included

Inlet Thread M30x1,5mm
2010/35/EU (TPED)

π TPED

VALVES

FIRE EXTINGUISHER'S AND FIRE SUPPRESSION SYSTEMS' VALVES



CODE 0119044

KX04 - 010 - 00

With brazen Nipple to adjust the Dip Tube

Valve for Dry Powder Fire Suppression Systems with Double Outlet. M30x1, 5mm, Manually and Fuse Activated.

Adaptor for M8x0,75 English Fuse (MBK03-PYR-2006C1, not included).

With **Bulb Glass Burst Pressure 68°C** for **Automatic Operation and Connection of Metal Wire (not included)** for Manual Activation.



CODE 0119085

KX04 - 010 - 48

Spare Bulb Glass 68°C for the Above Valve (KX04-010-00).



CODE 0119005

KX03 - 016E - 00

2Kg / 5Kg CO₂

(25E)

Burst Pressure disc 225+-22,5 bar

With brazen Nipple to Adjust the Dip Tube

CO₂ Valve Nickel Plated, Side Outlet W21.8X1/14.

PS 174bar (60°C), PT 250bar

CE (TUV)



CODE 0119006

KX03 - 007B1 - 00

2Kg / 5Kg CO₂

(25E)

Burst Pressure disc 225+-22,5 bar

With brazen Nipple to Adjust the Dip Tube

CO₂ Valve Nickel Plated, Side Outlet W21.8X1/14.

PS 174bar (60°C), PT 250bar

CE (TUV)



SPARE PARTS FOR FIRE EXTINGUISHERS AND FIRE SUPPRESSION SYSTEMS

VALVES

FIRE EXTINGUISHER'S AND FIRE
SUPPRESSION SYSTEMS' VALVES



CODE 0119058

KX03 - 016D - 00

CO₂ Valve
With Brazen Nipple to Adjust to
the Dip Tube.
Inlet Thread 1" NPT



CODE 0119051

KX03 - 001 - 00

CO₂ Valve
With Brazen Nipple to Adjust to
the Dip Tube.
Inlet Thread 19,2x14 (17E)



CODE 0119043

MBK19 - CO2HINGE - 17E

CO₂ Valve
front Outlet W21.7x14
Burst Pressure disc 240-280bar
PS 216bar, PT 315bar
Inlet Thread 19,2x14 (17E)

CE (TUV)

VALVES

FIRE EXTINGUISHER'S AND FIRE SUPPRESSION SYSTEMS' VALVES NICKEL PLATED



CODE 0119219

MBK14 - WN52 - 56A

CO₂ Valve

Main Use in Trolley Fire Extinguishers

Dip Tube Thread G¹/₄"

Inlet Thread 27,8x14 (25E)

Safety Bursting Disk 315±15bar

PS 200bar (60°C), PT 300bar

2010/35/EU (π) (TUV)



CODE 0119220

MBK14 - WN52 - 55

CO₂ Valve

Main Use in Trolley Fire Extinguishers

Dip Tube Thread G¹/₄"

Inlet Thread 27,8x14 (25E)

Safety Bursting Disk 225±25bar

PS 174bar (60°C),

PT 250bar

2010/35/EU (π) (TUV)



CODE 0119052

KX03 - 026N - 00

CO₂ Valve

Main Use in Trolleys

Inlet Thread 27,8x14 (25E)

Valve Outlet Thread W21.7-14

Dip Tube Thread M10x1mm

Safety Bursting Disk 260±26bar

PS 200bar (60°C),

PT 300bar

CE (TUV)



SPARE PARTS FOR FIRE EXTINGUISHERS AND FIRE SUPPRESSION SYSTEMS

VALVES

FIRE EXTINGUISHER'S AND FIRE SUPPRESSION SYSTEMS' VALVES



CODE 0119008

MBK03 - S - 023BR - CE

Valve for CO₂ Fire Suppression Systems.

Manual, Pneumatic or Fuse

Activation (fuse not included - MBK02-PYR).

Inlet Thread W28.8x1/14(55°)

Outlet Thread W21,8X1/14"

Fuse Thread G3/8"

PS 174bar, PT 250bar, 2010/35/EU (TPED)

π TPED



CODE 0119009

MBK03 - V - K8550

Valve for IG-541 / IG-55 and CO₂ Fire Suppression Systems.

Manual, Pneumatic or Fuse Activation

Outlet Thread W21,8X1/14"

Fuse Thread G3/8"

(fuse not included - MBK02-PYR)

Inlet Thread 25E According **DIN EN ISO 11363-1**

PS 300bar

PT 140bar

π (BAM) CE (VdS)



CODE 0119086

MBK04 - V - K8555

Valve for IG-541 / IG-55 Fire Suppression Systems, **Manual, Pneumatic or Fuse 1/4" Activation**

(fuse not included - MBK02-PYR)

With removable Pressure Gauge.

EN 12094-4

EN 12094-10:2003-09 (gauge)

Inlet Thread 25E According **DIN EN ISO 11363-1**

WP 200bar,

PT 210bar

π (BAM) CE (VdS)

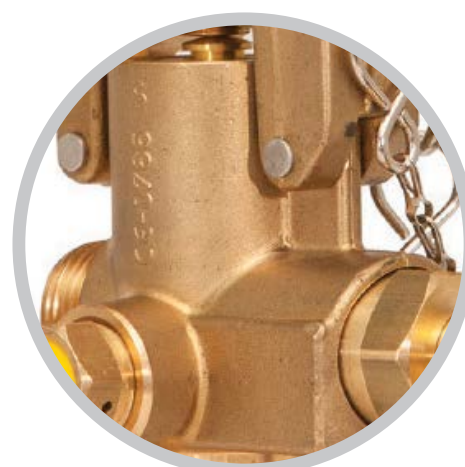

VALVES

FIRE EXTINGUISHER'S AND FIRE SUPPRESSION SYSTEMS' VALVES

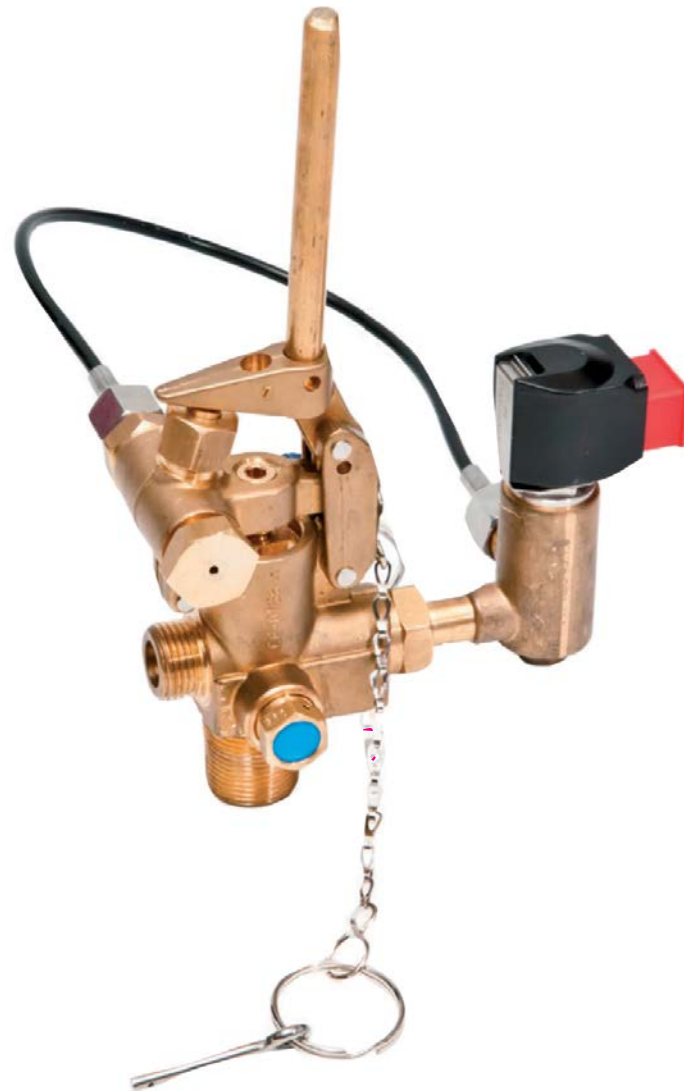

CODE 0112005

MBK04 - V - 19255

Solenoid Valve for CO₂ / IG-541 / IG-55
 Fire Suppression Systems

Inlet Thread 25E According **DIN EN ISO 629-1**

π (BAM) CE (VDS)



BRAZEN BLIND CAP

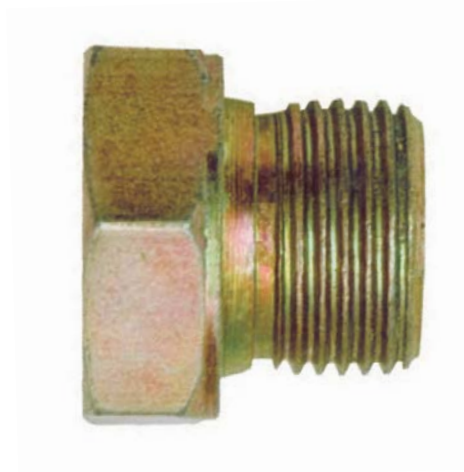

CODE 0124012

KX09 - 003 - 149

3/8" Brazen Cap, Appropriate for
 Sealing the Last CO₂ / IG-541 / IG-55
 Fire Suppression System Cylinder Valve
 or the Pilot Cylinder Valve.



SPARE PARTS FOR FIRE EXTINGUISHERS AND FIRE SUPPRESSION SYSTEMS

DISTRIBUTION VALVES

Distribution Valves

For CO₂ / IG-541 / IG-55 Systems - Activated
Pneumatically or by Electrically

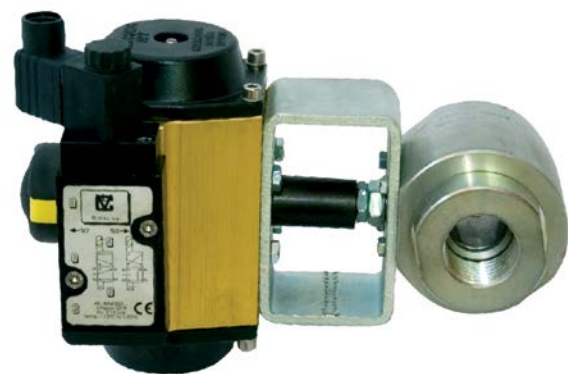

CODE 0112002

MBK04 - SRC - 100

1"
CE

CODE 0112004

MBK04 - SRC - 200

2"
CE

CODE 0112013

MBK04 - SRC - 150

1 1/2"
CE

CODE 0112014

MBK04 - SRC - 250

2 1/2"
CE

ALMOND ODORIZER

WP 60Bar PT 90Bar



CODE 0128085

MBK15 - SMELL - CO2



Almond Odorizer Cartridge used in Carbon Dioxide Fire Suppression Systems. The Cartridge in case of System Activation, releases an Almond odor in the odorless Carbon Dioxide gas, providing warning to the people left in the Area of System.

A single Cartridge can be on used in Fire Suppression System of 1.000Kg Carbon Dioxide

Activation Pressure: 3Bar ± 10%

PRESSURE REGULATOR 60 bar FOR IG SYSTEMS - CYLINDERS



CODE 0228102

MBK15 - REGULATOR



Inlet Pressure: 200/300Bar
Outlet Pressure: 60Bar
Inlet Thread: W21,8 x 1/14"
Outlet Thread: W21,8 x 1/14"

CE (Vds)

The Pressure Reducer - Regulator is connected to the Outlet of the Cylinder's Valve (either to those with gauge or those without Gauge). The Flexible EPDM hose is connected to the Outlet of the Regulator (Outlet It is shown in the Photo of the product with Nickel Color).

The Regulator adjust the Pressure of IG Mixture from 200Bar to 60Bar, with Smooth discharge the gas to low Pressure.

The Regulator is Vds Certified and recommended to be placed in every High Pressure Fire Suppression System.

FUSE



CODE **0119032**

MBK02 - PYR

1/4" fuse, for use in CO₂ / IG541 / IG55 / ABF - Wet Chemical / Dry Powder / Foam Fire Suppression System Valves.
Activation Voltage 12 - 24V DC
Includes Fuse's Coupling.



CODE **0119033**

MBK03 - PYR - 2006C1

M8x0,75 Fuse
(suitable for Valve KX04-010-00)

SAFETY PINS



CODE **0110005**

KX02 - 015 - 09 - 02B

Valve Safety Pin, Length 3,2cm,
Stainless Steel



CODE **0110000**

KX01 - 006 - 09 - 02A

Valve Safety Pin, Length 3,3cm



CODE **0110001**

KX09 - 006 - 00

Valve Safety Pin, Length 3cm



CODE **0119483**

MBK19 - PINTROLLEY-SINGLE

Valve Safety Pin for Trolley Fire Extinguishers,
Length 3,8cm



CODE **0119143**

KX05 - 004 - 09 - 02C

Stainless Steel Valve Safety Pin for
Trolley Fire Extinguishers, Length 3,8cm



CODE **0110003**

KX02 - 025D - 09

Stainless Steel Valve Safety
Pin, with Yellow / White Gauge
Protective Cover
(suitable for Valve Code
KX02-025G-00, INOX)



CODE **0110004**

KX02 - 015J - 09

Stainless Steel Valve Safety
Pin, with Yellow / Whit Gauge
Protective Cover
(suitable for Valve Code
KX02-015J-00 INOX)



CODE **0119182**

MBK13 - SPIN - GREEN - NEW

Stainless Steel Valve Safety Pin, with Green
Gauge Protective Cover
(suitable for Valve Code KX02-015J-00,
INOX)



Value in safety... Invest in Quality!

SPARE PARTS FOR FIRE EXTINGUISHERS AND FIRE SUPPRESSION SYSTEMS

VALVE SAFETY SEALS



CODE **0109300**

MBK18 - RED - PIN

Valve Safety Seal, **Pin Type**,
 Plastic



CODE **0109311**

MBK15 - SPIN - CARTR

Valve Safety Seal, **Pin Type**,
 Plastic, for Internal Cartridge Fire
 Extinguishers.



NEW

ASTRING TYPE VALVE SAFETY SEALS

Optional Printing of your Logo Upon Special Request.

Minimum Order Quantity: 10.000pcs



CODE **0109288**

MBK14 - SAFETYSEAL - GREEN

String Type Green
 (Engraved MBK)



CODE **0109001**

KX09 - 006 - 06C

String Type Blue
 (Engraved MBK)



CODE **0109119**

KX09 - 006 - 28F

String Type Yellow
 (Engraved MBK)



CODE **0109120**

KX09 - 006 - 28D2

String Type White
 (Engraved MBK)

ANNUAL INSPECTION RINGS

Inspection Rings Verify and
 prove that Inspection of the Fire
 Extinguisher has Been Made.

(The Rings Cannot be Inserted
 Unless the Fire Extinguisher's Valve is
 Unscrewed)



The Inspection Ring is Used During Inspection and Maintenance Procedures of Fire Extinguishers and is Placed Between Valve and Cylinder.

The Inspection Ring Bears the Inspection Year Engraved and Optionally Can Also include Company's Logo.

3.000pcs Minimum Order Quantity for Including Company's Logo.
 In Case of Smaller Quantity Order, the Inspection Rings will be without Logo.

The Inspection Rings are being Manufactured for all types of Fire Extinguishers.
 Color changes Every Year as Follows:

for years ending at 0		White
for years ending at 1		Yellow
for years ending at 2		Orange
for years ending at 3		Brown
for years ending at 4		Green
for years ending at 5		Blue
for years ending at 6		Purple
for years ending at 7		Grey
for years ending at 8		Dark Red
for years ending at 9		Black



SPARE PARTS FOR FIRE EXTINGUISHERS AND FIRE SUPPRESSION SYSTEMS



CODE 0119168

MBK15 - BURST - CARTR

Metallic Burst Disc for Knob - Type Fire Extinguishers.



CODE 0109312

MBK15 - SAFE - Y - CARTR

Yellow Safety Pin for Knob - Type Fire Extinguishers.



CODE 0109313

MBK15 - SAFE - G - CARTR

Green Safety Pin for Knob - Type Fire Extinguishers.



CODE 0109314

MBK15 - SAFE - B - CARTR

Blue Safety Pin for Knob - Type Fire Extinguishers.



**Inspection Ring with Engraved
Name of Your Company!**

REPAIR KIT



CODE 0149013

MBK09 - 015J - 00

Valve's Components Repair Kit (KX02-015J-00) in Plastig Bag.



CODE 0119134

KX - BX - 01

Overfilling Safety Valve for all Type of Fire Extinguishers Dry Powder - Foam - ABF Wet Chemical - Water.

O - RING



CODE 0119229

MBK15 - ORING - 68X4

O - RING D: 68x4mm suitable for Knob - Type Valves.

CODE 0119068

KX10 - 084E - 00

O - RING D: 14x2mm (External diameter x Thickness), in Plastig Bag containing 50pcs, for Dry Powder Discharge Hoses of 3kg/6kg/12kg & Foam 6lt/9lt.

CODE 0119088

KX10 - 219 - 00

O - RING D: 33,5x2,5mm (External diameter x Thickness), in Plastig Bag containing 50pcs, for Valves M30x1,5mm. For all Dry Powder and Foam Cylinders.

CODE 0119210

MBK14 - ORING - 34x2.5

O - RING D: 34x2,5mm (External diameter x Thickness), in Plastig Bag containing 50pcs, for Valves M30x1,5mm. For all Dry Powder and Foam Cylinders.

CODE 0119031

KX07 - 012 - 10

O - RING D: 34x3mm (External diameter x Thickness), in Plastig Bag containing 50pcs, for Valves M30x1,5mm. For Cylinders of other Manufacturers.

CODE 0119107

KX10 - 292 - 00

O - RING D: 34,5x3,25mm (External diameter x Thickness), in Plastig Bag containing 50pcs, for Valves 30x1,5 with Double Outlet, for Local Application Fire Extinguishers 6kg/12kg and for INOX & Ceiling Fire Extinguishers.

CODE 0119087

KX10 - 220 - 00

O - RING D: 36,5x3,5mm (External diameter x Thickness), in Plastig Bag containing 50pcs, for Local Application Cast brazen Unions of Single & Double Outlet type.

CODE 0119029

KX10 - 084B - 00

O - RING D: 29x2,65mm (External diameter x Thickness), in Plastig Bag containing 50pcs, for Valves M24x1,5mm.

CODE 0119069

KX02 - 045 - 10

O - RING D: 28x3mm (External diameter x Thickness), in Plastig Bag containing 50pcs, for Valves M24x1,5mm.

CODE 0119030

KX07 - 035 - 10

O - RING D: 29x3,5mm (External diameter x Thickness), in Plastig Bag containing 50pcs, for Valves M24x1,5mm.

CODE 0119109

KX10 - 293 - 00A

O - RING D: 51x3mm (External diameter x Thickness), in Plastig Bag containing 50pcs, for Valves of Trolley Fire Extinguishers with external thread. To be used together with O-ring (KX10-293-00)

CODE 0119108

KX10 - 293 - 00

O - RING D: 51x3,5mm (External diameter x Thickness), in Plastig Bag containing 50pcs, for Valves of Trolley Fire Extinguishers with external thread. To be used together with O-ring (KX10-293-00)

CODE 0119112

KX05 - 004 - 10A/CE

O - RING D: 45x3,5mm (External diameter x Thickness), in Plastig Bag containing 50pcs, for Valves of Trolley Fire Extinguishers with external thread. (Internal O-ring).

CODE 0119410

MBK19 - ORING - 37.5X4.5

(External diameter x Thickness), in Plastig Bag containing 50pcs, for Valves of Local application Fire Extinguishers 25Kg, 50Kg, 25Lt & 50Lt.



SPARE PARTS FOR FIRE EXTINGUISHERS AND FIRE SUPPRESSION SYSTEMS

FOAM GENERATOR NOZZLES



CODE 0103001

KX09 - 003 - 28D

1Lt / 2Lt

G1/8 x 28 Metallic Foam Generator Nozzle

(For Valve KX01-009F-00/CE1)



CODE 0103000

KX09 - 003 - 28B

3Lt

G1/4 x 19 Metallic Foam Generator Nozzle

(For Valve KX02-017H-00/CE2)



CODE 0103019

MBK13 - NOZZLE - BSI

2Lt

G1/8 x 28 Plastic Foam Generator Nozzle

for 2lt ABF Fire Extinguisher.

NOZZLES

Nozzle G1/4 for Dry Powder Valves
(KX02-017H-00/CE2)



CODE 0119002

KX02 - 001A - 03A

3Kg

Plastic



CODE 0119004

KX09 - 004 - 12

3Kg

Metallic with O - Ring

SPARE STRING



CODE 0109003

KX01 - 008 - 09 - 01

Plastic Spare String, for Connecting
Valves with Safety Pins.

GAUGES

Nickel Plated Gauges with testing hole, **with O - Ring and filter.** High Strength, Water Proof and Great Performance in Long Term Pressure Applications.



Available Gauges
 with Serial
 Number Printed
 on every Item
 for Impeccable
 Traceability



CODE 0121026

KX09 - MBK - G23 - G

For Dry Powder & ABF Wet Chemical Fire Extinguishers
 M10x1mm
 0 - 27bar

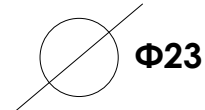

CODE 0121032

MBK14 - MBK - FOAM - G23B

For Foam Fire Extinguishers
 M10x1mm
 0 - 27bar

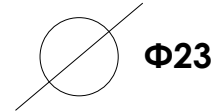

CODE 0121031

MBK13 - MBK - FOAM - G27B

For Foam Fire Extinguishers
 M10x1mm
 0 - 27bar

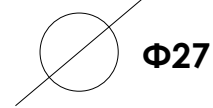

CODE 0121027

KX09 - MBK - G27B - G

For Dry Powder & ABF Wet Chemical Fire Extinguishers
 M10x1mm
 0 - 27bar

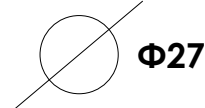

CODE 0121037

MBK15 - 27A012S

Suitable for MEDFIRE, MBK12-MEDFIRE
 M10x1mm
 0 - 22bar





SPARE PARTS FOR FIRE EXTINGUISHERS AND FIRE SUPPRESSION SYSTEMS

GAUGES

GAUGE WITH O - RING AND FILTER



Available Gauges with Serial Number Printed on every item for Impeccable Traceability



CODE 0121001

KX09 - MBK - G23

Φ23 Nickel Plated Gauge with Filter and O-Ring. For Dry Powder Fire Extinguishers. M10x1mm
0 - 27bar

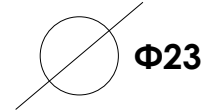

CODE 0121004

KX09 - MBK - G27B

Φ27 Nickel Plated Gauge for Dry Powder Fire Extinguishers. M10x1mm
0 - 27bar

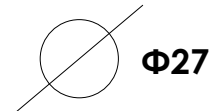

CODE 0121002

KX09 - MBK - G25

Φ25 Gauge with Filter, without O-Ring. 1/8 NPT
0 - 24bar

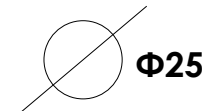

CODE 0121000

KX09 - 020A - 00

Φ30 Gauge with Filter and O-Ring. M10x1mm
0 - 28bar

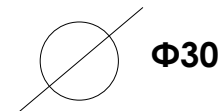

CODE 0121046

MBK19 - 23CA170S

For Clean Agent Fire Extinguishers with Filter and O-Ring. M10x1mm
0 - 35bar

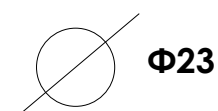

GAUGES



Available Gauges
 with Serial
 Number Printed
 on every item
 for Impeccable
 Traceability



CODE 0121028

MBK13 - MBK - G35B

Φ35 Metallic Gauge, 0-27bar, with Filter and O-Ring, for Trolley Fire Extinguishers and Fire Suppression Systems.

M10x1mm
 0 - 27bar

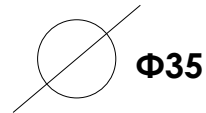

CODE 0121016

KX09 - 057 - 00

Φ63 Gauge for Low Pressure Fire Suppression Systems' Networks. Dry Powder - Foam - ABF-Wet Chemical

1/4" NPT
 0 - 25bar

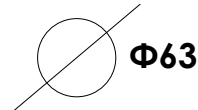

CODE 0121030

MBK13 - MBK - FOAM - G35B

Φ35 Gauge, for Foam Trolley Fire Extinguishers

M10x1mm
 0 - 27bar

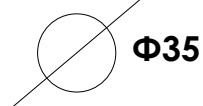

CODE 0121035

MBK14 - GAUGE - G40

Φ40 Gauge, for Dry Powder Local Application Systems (for Gas Stations).

M10x1mm
 0 - 45bar with Green Area at 16 - 28bar

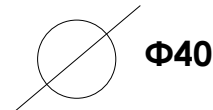

CODE 0121034

MBK14 - GAUGE - TEST

Pressure Tester
 To control the Good Operation of Portable Fire extinguishers' Gauges.

M10x1mm
 0 - 25bar



SPARE PARTS FOR FIRE EXTINGUISHERS AND FIRE SUPPRESSION SYSTEMS

DRY POWDER DISCHARGE HOSES GALVANISED CLIPS AND COUPLINGS



Available Gauges
with Serial
Number Printed
on Every Item
for Impeccable
Traceability



CODE 0120095
KX - HLC - 05 - 03

6Kg
EPDM
With Magnet
L: 53cm
PT 27bar



CODE 0120128
MBK15 - HLC - 05 - 03 - YL

6Kg
EPDM
With Magnet
L: 53cm
PT 27bar



CODE 0120096
KX - HLC - 05 - 04

9Kg / 12Kg
EPDM
With Magnet
L: 62cm
PT 27bar



CODE 0120129
MBK15 - HLC - 05 - 04 - YL

9Kg / 12Kg
EPDM
With Magnet
L: 62cm
PT 27bar

DRY POWDER DISCHARGE HOSES GALVANISED CLIPS AND COUPLINGS



CODE 0120070
KX - HLC - 05 - 05

3Kg
PVC
Without Magnet
PT 26bar



CODE 0120006
KX09 - 007 - 03A1

6Kg
PVC
With Magnet
L: 53cm
PT 27bar



CODE 0120104
MBK13 - DIS - 9KG

9Kg
PVC
With Magnet
PT 26bar



CODE 0120005
KX09 - 007 - 03B1

9Kg / 12Kg
PVC
With Magnet
PT 24bar

SPARE PARTS FOR FIRE EXTINGUISHERS AND FIRE SUPPRESSION SYSTEMS

EPDM Discharge Hoses for Foam/Water/
ABF-Wet Chemical Fire Extinguishers, 26bar
with Burst Pressure at 98bar



CODE 0120072

KX - HLC - 04 - 04

6Lt / 9Lt
EPDM
L: 64,5 cm



CODE 0120127

MBK15 - HLC - 04 - 04 - BL

6Lt / 9Lt
EPDM
L: 64,5cm



CODE 0120108

MBK14 - HLC - 04 - 04 - GREEN

6Lt / 9Lt
EPDM
L: 64,5cm

WITH MAGNET TO CONENCT WITH VESSEL
GALVANISED CLIPS AND
COUPLINGS NEW SPECIAL TYPE NOZZLE FOAM
NOZZLE GENERATOR
MADE FROM REINFORCED PLASTIC



CODE 0120097

MBK11 - SPARE - MAGNET

6Kg / 9Kg / 12Kg & 6Lt / 9Lt Spare Additional Magnet for
Holding Discharge Hose at Dry Powder/Foam/Water/
ABF-Wet Chemical Fire Extinguishers.
To be Used Instead of Plastic Belt.

Available Hoses
with Serial Number
Printed on Every
Item for Impeccable
Traceability

DISCHARGE HOSES FOR DRY POWDER FIRE EXTINGUISHERS WITH INTERNAL CARTRIDGE

Free Rotation
Coupling

Available Hoses
with Serial Number
Printed on Every
Item for Impeccable
Traceability



CODE 0120156

MBK19 - DISHOSE - RD - 6KG

6Kg
L: 62,5cm **PT 27bar**
EPDM Discharge Hose, 27bar, for **Dry Powder**
Fire Extinguishers with Internal Cartridge.



CODE 0120157

MBK19 - DISHOSE - RD - 9KG

9Kg
L: 66,5cm **PT 27bar**
EPDM Discharge Hose, 27bar, for **Dry Powder**
Fire Extinguishers with Internal Cartridge.



CODE 0120117

MBK14 - DISHOSE - Y - 6KG

6Kg
L: 62,5cm **PT 27bar**
EPDM Discharge Hose, 27bar, for **Dry Powder** Fire
Extinguishers with Internal Cartridge.



CODE 0120118

MBK14 - DISHOSE - Y - 9KG

9Kg
L: 66,5cm **PT 27bar**
EPDM Discharge Hose, 27bar, for **Dry Powder**
Fire Extinguishers with Internal Cartridge.



CODE 0120161

MBK19-DISHOSE-VR-6KG

6Kg
L: 64,5cm **PT 30bar**
EPDM Discharge Hose, 30bar, for **Dry Powder**
Fire Extinguishers with Internal Cartridge, Red.



CODE 0120166

MBK19-DISHOSE-VR-9KG

9Kg
L: 66,5cm **PT 30bar**
EPDM Discharge Hose, 30bar, for **Dry Powder**
Fire Extinguishers with Internal Cartridge, Red.



SPARE PARTS FOR FIRE EXTINGUISHERS AND FIRE SUPPRESSION SYSTEMS

DISCHARGE HOSES FOR FIRE EXTINGUISHERS WITH INTERNAL CARTRIDGE ABF - WET CHEMICAL



Free Rotation Coupling

Available Hoses
with Serial Number
Printed on Every
Item for Impeccable
Traceability



CODE 0120158

NEW

MBK19 - DISHOSE - RD - 6LT

6Lt

L: 65,3cm | PT 30bar

EPDM Discharge Hose, 30bar, for **Foam / Water** Fire Extinguishers with Internal Cartridge.



CODE 0120159

NEW

MBK19 - DISHOSE - RD - 9LT

9Lt

L: 69,3cm | PT 30bar

EPDM Discharge Hose, 30bar, for **Foam / Water** Fire Extinguishers with Internal Cartridge.



CODE 0120111

MBK14 - DISHOSE - G - 6LT

6Lt

L: 65,3cm | PT 30bar

EPDM Discharge Hose, 30bar, for **Foam / Water** Fire Extinguishers with Internal Cartridge.



CODE 0120112

MBK14 - DISHOSE - G - 9LT

9Lt

L: 69,3cm | PT 30bar

EPDM Discharge Hose, 30bar, for **Foam / Water** Fire Extinguishers with Internal Cartridge.

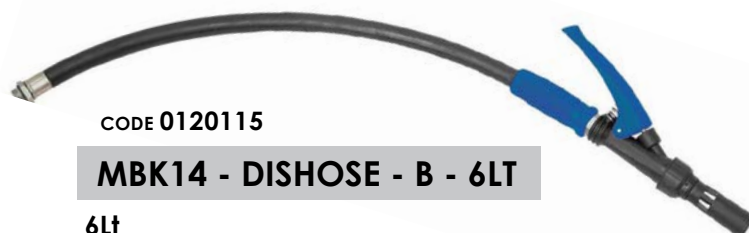

CODE 0120115

MBK14 - DISHOSE - B - 6LT

6Lt

L: 78,3cm | PT 30bar

EPDM Discharge Hose, 30bar, for **ABF - Wet Chemical** Fire Extinguishers with Internal Cartridge.



CODE 0120116

MBK14 - DISHOSE - B - 9LT

9Lt

L: 86,3cm | PT 30bar

EPDM Discharge Hose, 30bar, for **ABF - Wet Chemical** Fire Extinguishers with Internal Cartridge.



CODE 0120167

NEW

MBK19-DISHOSE-VR-6LT

6Lt

L: 65,5cm | PT 30bar

EPDM Discharge Hose, 30bar, for **Foam** Fire Extinguishers with Internal Cartridge, Red.



CODE 0120168

NEW

MBK19-DISHOSE-VR-9LT

9Lt

L: 67,5cm | PT 30bar

EPDM Discharge Hose, 30bar, for **Foam** Fire Extinguishers with Internal Cartridge, Red.

DISCHARGE HOSES FOR TROLLEY FIRE EXTINGUISHERS

25Kg / 50Kg / 100Kg & 25Lt / 50Lt / 100Lt
 Dry Powder/Foam / Water EPDM Discharge Hose with
 Gun-Type Nozzle of Adjustable Discharge (not squeeze
 lever nozzle), for Trolley Fire Extinguishers.



**REINFORCED
 STAINLESS STEEL
 SPRING**

**IMPROVED MECHANICAL
 PROPERTIES OF HOSE AND
 GUN-TYPE NOZZLE**

Available Hoses
 with Serial Number
 Printed on Every
 Item for Impeccable
 Traceability



CODE 0120038

KX07 - 069C - 00

Dry Powder G^{3/4}" 5m
 PT 28bar
 with Gun Type Nozzle



CODE 0120010

KX07 - 069D - 00

Foam/Water G^{3/4}" 5m
 PT 28bar
 with Gun Type Nozzle

CODE 0120051

KX07 - 069C2 - 00

Dry Powder G^{1/2}", 5m
 PT 30bar
 with Gun Type Nozzle

CODE 0120056

KX07 - 069D2 - 00

Foam/Water G^{1/2}" 5m
 PT 28bar
 with Gun Type Nozzle



CODE 0120093

MBK12 - DISCHARGE - 3/4

Dry Powder Discharge Hose, G^{3/4}", 5m
 with Squeeze Lever Nozzle for Welded
 Type Trolley Fire Extinguishers
 PT 28bar



CODE 0120124

MBK12 - DISCHARGE - FOAM - 3/4

Foam/Water Discharge Hose, G^{3/4}",
 5m with Squeeze Lever Nozzle for
 Welded Type Trolley Fire Extinguishers
 PT 28bar



SPARE PARTS FOR FIRE EXTINGUISHERS AND FIRE SUPPRESSION SYSTEMS

TROLLEY EXTINGUISHERS DISCHARGE HOSES

Available Hoses with Serial Number Printed on Every Item for Impeccable Traceability

CODE 0120089

MBK08 - M - 05 - 063

6Lt
L: 1,09m
PT 26bar
EPDM Discharge Hose with Special Type Nozzle.



CODE 0114080

MBK12 - 006 - 14F

6Lt
Galvanized ring for Fire Hose MBK08-M-05-063 for Fire Extinguishers.



Usage of **Soft Foam** Material on the Internal of the Cylinder so that to Avoid Scratches or Damages on the Cylinder

DISCHARGE HOSE WITH HORN

Available Hoses with Serial Number Printed on every item for Impeccable Traceability

CODE 0120083

KX - HLC - 06 - 00

L: 1,42m
High Pressure EPDM Discharge Hose with Horn for 5Kg CO₂ Fire Extinguisher, with Metal Couplings and **Wooden Handle** Offering Extra Protection Against Static Electricity.

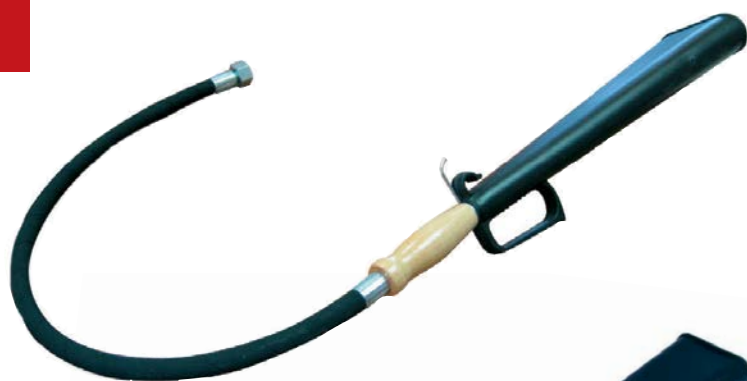

CODE 0124027

KX10 - 085D - 00

Washer 19,8x10,5x1,8mm - Plastic for hose with **Horn of 5Kg CO₂ fire Extinguisher**. Fitted to the outlet of the Valve, at the connection of the Hose with the Horn.

CODE 0120073

KX - HLC - 02 - 02

Total L: 5,8m
5m
High Pressure EPDM Discharge Hose with Horn and Flow Switch Nozzle for CO₂ Trolley Fire Extinguisher, with Metal Couplings and **Wooden Handle** offering extra protection against static electricity. Meeting the Requirements of EN1866.
EN 853



CODE 0120071

KX - HLC - 02 - 03

Total L: 8,8m
8m
High Pressure EPDM Discharge Hose with Horn and Flow Switch Nozzle for CO₂ Trolley Fire Extinguisher, with metal couplings and **Wooden Handle** offering extra protection against static electricity. Meeting the Requirements of EN1866.
EN 853

SPARE PARTS FOR FIRE EXTINGUISHERS AND FIRE SUPPRESSION SYSTEMS



CODE 0129426

MBK19 - CO2 - 05 - 02I

Discharge Hose Compatible
 with CO₂ Trolley
 Length: 2m
 Hose Length: 5m

CODE 0129429

MBK19 - CO2 - 08 - 02I

Discharge Hose Compatible
 with CO₂ Trolley
 Length: 2m
 Hose Length: 8m



CODE 0129427

MBK19 - CO2 - 05 - 02K

Discharge Hose Compatible
 with CO₂ Trolley
 Length: 1,99m
 Hose Length: 5m

CODE 0129428

MBK19 - CO2 - 08 - 02K

Discharge Hose Compatible
 with CO₂ Trolley
 Length: 1,99m
 Hose Length: 8m



CODE 0120081

KX07 - 069 - 87

Spare Discharge Nozzle for **Dry Powder** Gun Type Nozzle.



CODE 0120082

KX07 - 069A - 88

Spare Discharge Nozzle for **Foam** Gun Type Nozzle.



CODE 0120066

KX07 - 069 - 00

Spare Gun for Dry Powder / Foam / Water.
 (Nozzle is not included)

O-RING FOR DISCHARGE HOSES OF DRY POWDER / FOAM TROLLEY FIRE EXTINGUISHERS

- D: (Inter. x Exter. x Thickn.) = **(30mm x 15mm x 3mm)** (between the Discharge Hose and the Valve)
- D: (Inter. x Exter. x Thickn.) = **(24mm x 15mm x 2,5mm)** (between the Discharge Hose and the Gun)



CODE 0124168

KX10 - 373 - 00

TEFLON O - ring for Trolley Fire Extinguisher
 Discharge Hoses (VALVE - HOSE)



CODE 0124169

KX10 - 373A - 00

TEFLON O - ring for Trolley Fire Extinguisher
 Discharge Hoses (HOSE - NOZZLE)



SPARE PARTS FOR FIRE EXTINGUISHERS AND FIRE SUPPRESSION SYSTEMS

HEAVY DUTY NOZZLES

Available Hoses
with Serial
Number Printed
on Every Item
for Immediate
Traceability!



CODE 0138005

KX09 - 009 - 07

2Kg
L: 11cm
D: 99,2cm
CO₂ Heavy Duty Horn with Metallic Nut
(for Front Outlet Valve KX03-016E-00).



ANTIFROST

CODE 0130002

KX09 - 012 - 00

2Kg
L: 32cm
CO₂ Heavy Duty Horn for Valve
with Side Outlet (KX03-007B1-00)

PLASTIC BELT

Plastic **Belt** for Holding the Discharge Hose of Dry Powder / Foam /
ABF - Wet Chemical / Water Mist Fire Extinguisher.



CODE 0117000

KX09 - 006 - 14G

3Kg / 6Kg / 6Kg INOX & 3Lt / 6Lt
Length 59cm

CODE 0117001

KX09 - 006 - 14

9Kg / 12Kg & 9Lt
Length 71,5cm

Made of Flexible Durable Plastic!

DRY POWDER DISCHARGE NOZZLE

Fitted to the Trolley Operated Fire Extinguishers Hose.
PT 27bar



CODE 0134003

KX09 - 001 - 01A

Outlet Thread M16 x 1,5mm

FOAM NOZZLE

Plastic **Foam generator**, with Male Thread Fitted to the
Above KX09-001-01A Discharge Gun for Conversion
into **Foam**.



CODE 0103005

KX09 - 008 - 00

Nozzle Thread M16 x 9mm

SPARE PARTS FOR FIRE EXTINGUISHERS AND FIRE SUPPRESSION SYSTEMS

PLASTIC FRAME FITTINGS



CODE 0134048

MBK14 - Y - FOOT - 6KG - CARTR

6Kg

Plastic Frame Fitting for **Dry Powder** Fire Extinguishers with Internal Cartridge.



CODE 0134044

MBK14 - G - FOOT - 6LT - CARTR

6Lt

Plastic Frame Fitting for **Foam / Water** Fire Extinguishers with internal Cartridge.



CODE 0134046

MBK14 - B - FOOT - 6LT - CARTR

6Lt

Plastic Frame Fitting for **Foam / ABF - Wet Chemical** Fire Extinguishers with Internal Cartridge.



CODE 0134050

MBK15 - YELLOW - FOOT - 6LT

6Lt

Plastic Frame Fitting for Fire Extinguishers



CODE 0134039

MBK13 - GREEN - FOOT - 6LT

6Lt

Plastic Frame Fitting for **ECO Foam** Constant Pressure Fire Extinguishers.



CODE 0134042

MBK14 - BLUE - FOOT - 6LT

6Lt

Plastic Frame Fitting for **ABF - Wet Chemical** Constant Pressure Fire Extinguishers.



CODE 0134054

MBK18 - BLACK - FOOT - 6LT

6Lt

Plastic Frame Fitting for **Dry Powder / Foam / ABF - Wet Chemical** Fire Extinguishers



CODE 0134064

MBK19 - FOOT - BLACK - 6

6Lt / 6Kg

Plastic Frame for Vessel Ø160mm (For vessels 6lt / 6kg contant pressure).



CODE 0134067

MBK19 - FOOT - BLACK - 9

9Lt / 9Kg

Plastic Frame for Vessel Ø180mm (For Vessels 9lt / 9kg Contant Pressure).

CODE 0134049

MBK14 - Y - FOOT - 9KG - CARTR

9Kg

Plastic Frame Fitting for **Dry Powder** Fire Extinguishers with Internal Cartridge.

CODE 0134045

MBK14 - G - FOOT - 9LT - CARTR

9Lt

Plastic Frame Fitting for **Foam / Water** Fire Extinguishers with Internal Cartridge.

CODE 0134047

MBK14 - B - FOOT - 9LT - CARTR

9Lt

Plastic Frame Fitting for **Foam/ ABF - Wet Chemical** Fire Extinguishers with Internal Cartridge.



CODE 0134051

MBK15 - YELLOW - FOOT - 9LT

9Lt

Plastic Frame Fitting for Fire Extinguishers

CODE 0134040

MBK13 - GREEN - FOOT - 9LT

9Lt

Plastic Frame Fitting for **ECO Foam** Constant Pressure Fire Extinguishers.

CODE 0134043

MBK14 - BLUE - FOOT - 9LT

9Lt

Plastic Frame Fitting for **ABF - Wet Chemical** Constant Pressure Fire Extinguishers.



CODE 0134055

MBK18 - BLACK - FOOT - 9LT

9Lt

Plastic Frame Fitting for **Dry Powder /Foam/ ABF - Wet Chemical** Fire Extinguishers



CODE 0134065

MBK19 - FOOT - GREEN - 6

6Lt / 6Kg

Plastic Frame for Vessel Ø160mm (For vessels 6lt / 6kg contant pressure).





SPARE PARTS FOR FIRE EXTINGUISHERS AND FIRE SUPPRESSION SYSTEMS

SPARE INTERNAL CARTRIDGE



CODE 0128039

MBK14 - CARTR - P - 120

6Kg
Spare Internal Cartridge for
Dry Powder Fire Extinguishers.
Thread: **M16x1,5mm**
L: **270±10 mm**
Capacity CO₂: 120g
2010/35/EU (π) (TUV) EN1964-1

CODE 0128050

MBK14 - CARTR - P - 180

9Kg
Spare Internal Cartridge for
Dry Powder Fire Extinguishers.
Thread: **M16x1,5mm**
L: **380±10mm**
Capacity CO₂: 180gr
D: **35mm**
2010/35/EU (π) (TUV) EN1964-1

CODE 0128105

MBK17 - GPD6 - CARTRIDGE

Spare Internal Cartridge for **Dry Powder Fire Extinguishers.**
Capacity CO₂: **150gr**
For **6kg, MBK15 - 060PA - GPD6-A**
Thread: **M18x1,5mm**
L: **355±10mm, 325±10mm**
D: **35mm**
2010/35/EU (π) (TUV) EN ISO 9809

CODE 0128103

MBK17 - GFM6 - CARTRIDGE

Spare Internal Cartridge for **Foam Fire Extinguishers.**
Include special Plastic External Coating Antioxidation.
Capacity CO₂: **55gr**
For **6lt, MBK15 - 060AF - GFM6-H**
Thread: **M18x1,5mm**
L: **220±10mm, 240±10mm**
D: **28mm**
2010/35/EU (π) (TUV) EN ISO 9809

CODE 0128104

MBK17 - GFM9 - CARTRIDGE

Spare Internal Cartridge for **Foam Fire Extinguishers.**
Include special Plastic External Coating Antioxidation.
Capacity CO₂: **75gr**
For **9lt, MBK15 - 090AF - GFM9-H**
Thread: **M18x1,5mm**
L: **205±10mm, 190±10mm**
D: **28mm**
2010/35/EU (π) (TUV) EN ISO 9809



CODE 0128066

MBK14 - CARTR - F - 65

6Lt
Spare Internal Cartridge for
ABF - Wet Chemical / Foam.
Fire Extinguishers. Include special
Plastic External Coating Antioxidation.
Thread: **M16x1,5mm**
L: **282±10 mm**
Capacity CO₂: **65gr**
D: **28mm**
2010/35/EU (π) (TUV) EN1964-1

CODE 0128038

MBK14 - CARTR - F - 75

9Lt
Spare Internal Cartridge for
ABF - Wet Chemical / Foam Fire
Extinguishers. Include Special
Plastic External Coating **Thread:**
M16x1,5mm
L: **282±10 mm**
Capacity CO₂: **75gr**
D: **28mm**
2010/35/EU (π) (TUV) EN1964-1

SPARE EXTERNAL CARTRIDGE FOR TROLLEY FIRE EXTINGUISHERS

CODE 0128131



MBK19 - CARTR - N2 - 50LT

Spare N₂ external Cartridge for Trolley
Fire Extinguisher **50Lt**
MBK15 - 500AF - EXT

CODE 0128114



MBK19 - CARTR - N2 - 50KG

Spare N₂ external Cartridge for Trolley
Fire Extinguisher **50Kg**
MBK14 - 500PA - EXT

CODE 0128071



MBK17 - CARTR - 50L

Spare CO₂ External Cartridge for
MBK14-500AF-EXT Fire Extinguisher
Thread: **25E**
L: **345 ± 5 mm**
Capacity: **340gr**
D: **103 ± 1,03mm**
Temperature Range: **-30°C to +60°C**
Cylinder Volume: **1,7Lt**
2010/35/EU (π)



SPARE PARTS FOR FIRE EXTINGUISHERS AND FIRE SUPPRESSION SYSTEMS

DRY POWDER DIP TUBE WITH THREAD AT ONE END FOR STORED PRESSURE FIRE EXTINGUISHERS

For Portable Dry Powder Fire Extinguishers
M16x1,5mm
PVC



At The Other End
45° Cut Angle

CODE 0122002

KX09 - 010 - 01P

1Kg
L: 20,50cm, OD: 16mm, ID: 12mm

CODE 0122003

KX09 - 010 - 01P1

2Kg
L: 29cm, OD: 16mm,
ID: 12mm

CODE 0122005

KX09 - 010 - 01P2

3Kg
L: 34,5cm, OD:16mm
ID: 12mm

CODE 0122008

KX09 - 010 - 01P4

6Kg
L: 43cm, OD: 16mm, ID: 12mm
(Suitable also for 6Kg Local
Application Fire Extinguisher with
Single or Double Outlet Valve)

CODE 0122043

MBK13 - TUBE - 9KG

9Kg
L: 49cm, OD: 16mm, ID: 12mm

CODE 0122009

KX09 - 010 - 01P5

12Kg
L: 51,5cm, OD:16mm, ID: 12mm
(Suitable also for 12Kg Local
Application Fire Extinguisher with
Single or Double Outlet Valve).

FOAM / ABF - WET CHEMICAL / WATER FIRE EXTINGUISHERS DIP TUBE WITH THREAD AT ONE END AND FILTER TO THE OTHER

For Fire Extinguishers Foam / ABF - Wet Chemical / Water



CODE 0122036

KX09 - 010 - 57B

1Lt
L: 23cm, OD: 16mm, ID: 13mm

CODE 0122038

MBK07 - MBK - DT2LT

2Lt
L: 27cm, OD:16mm, ID: 12mm

CODE 0122039

MBK07 - MBK - DP3LT

3Lt
L: 32,50cm, OD: 16mm, ID: 12mm

CODE 0122033

KX09 - 010 - 57

6Lt
L: 43cm, OD: 16mm, ID: 12mm

CODE 0122034

KX09 - 010 - 57A

9Lt
L: 48cm, OD: 16mm, ID: 12mm

TROLLEY DIP TUBE WITH THREAD AT ONE END FOR STORED PRESSURE FIRE EXTINGUISHERS



CODE 0122017

KX09 - 010 - 07B

25 / 50Kg
L: 87cm

Suitable for Dry Powder Trolley Fire
Extinguishers
OD=27mm, ID=19mm,
At the One End 3/4" BSP,
At the Other End 45° Cut Angle

CODE 0122040

MBK07 - MBK - DT25LT

25Lt
L: 71cm

Suitable for Foam Trolley Fire Extinguishers
Dip tube OD=27mm, ID=19mm, at One End 3/4" BSP,
at the Other end Tread Suitable for Filter KX09 - 004 - 95.
Filter Included.

CODE 0122037

KX09 - 010 - 07B1

50Lt
L: 86,5cm



SPARE PARTS FOR FIRE EXTINGUISHERS AND FIRE SUPPRESSION SYSTEMS

DIP TUBE FOR CO₂ FIRE EXTINGUISHERS WITH THREAD

CODE 0122028

KX09 - 010 - 01J5

2Kg / 5Kg
L: 80cm, OD: 10mm, ID: 6mm

For Fire Extinguishers **2Kg / 5Kg CO₂**
Suitable for Valve
0119052 & 0119006

CODE 0122035

KX09 - 010 - 36

5Kg
L: 59cm, OD: 13mm, ID: 9mm

For Fire Extinguisher **5Kg CO₂ G¹/₄"**
Suitable for Valve
0119219 / 0119220 & 0119005

DIP TUBE FOR CO₂ CYLINDERS WITH THREAD

CODE 0122022

KX09 - 010 - 01J4

10Kg - 60Kg
L: 300cm, OD: 10mm, ID: 6mm
Suitable for Valve 0119052

CODE 0122044

MBK15 - DIPTR - 80

16Lt - 10Kg
L: 80cm

For Cylinder **16Lt**,
Thread: G¹/₄"
and for Trolley Fire Extinguisher
10Kg CO₂.
OD: 13mm, ID: 9mm
Suitable for Valve
0119219/ 0119220

CODE 0122060

MBK15 - DIPTR - 116

40Lt - 30Kg CO₂
L: 116cm

For Cylinder **40Lt**,
Thread: G¹/₄"
OD: 13mm, ID: 9mm
Suitable for Valve
0119219/ 0119220

CODE 0122061

MBK15 - DIPTR - 142

67,5Lt & 45Kg CO₂
L: 142cm

For Cylinder **67,5Lt**,
Thread: G¹/₄"
OD: 13mm, ID: 9mm
Suitable for Valve 0119219/
0119220

CODE 0122062

MBK15 - DIPTR - 300

30Kg - 60Kg CO₂
Thread: G¹/₄"
L: 300cm
OD: 13mm, ID: 9mm
For Cylinder from **45Kg** up to **60Kg**
CO₂

CODE 0122004

KX09 - 010 - 01P6

Suitable for Use in Permanent
System with Valve
L: 300cm
OD: 16mm, ID: 12mm



NEW

CODE 0122063

MBK19 - 27CO₂ - DIPTUBE

27Kg CO₂
Suitable for Valve 0119228
L: 116cm
OD: 16mm, ID: 12mm



NEW

SPARE PARTS FOR FIRE EXTINGUISHERS AND FIRE SUPPRESSION SYSTEMS

DIP TUBE FOR LOCAL APPLICATION FIRE EXTINGUISHERS



CODE 0122045

MBK14 - DIPTUBE - 25L

25L
 L: **61cm**, OD: **12mm**, ID: **16mm**
 Local Application Dip Tube with Filter

CODE 0122047

MBK14 - DIPTUBE - 25KG

25Kg
 L: **61cm**, OD: **12mm**, ID: **16mm**
 Local Application Dip Tube Without Filter

CODE 0122048

MBK14 - DIPTUBE - 50L

50L
 L: **84cm**, OD: **12mm**, ID: **16mm**
 Local Application Dip Tube with Filter

CODE 0122046

MBK14 - DIPTUBE - 19,5L

19,5L
 L: **76cm**, OD: **16mm**, ID: **12mm**
 Local Application Dip Tube with Filter

DIP TUBE FOR CARTRIDGE TYPE FIRE EXTINGUISHERS



CODE 0122053

MBK14 - DIP - PKNOB - 6

6Kg
 L: **43cm**, OD: **18mm**, ID: **12mm**
 Dip Tube for Dry Powder Knob
 Operated Fire Extinguishers

CODE 0122055

MBK14 - DIP - PKNOB - 9

9Kg
 L: **49cm**, OD: **18mm**, ID: **12mm**
 Dip Tube for Dry Powder Knob
 Operated Fire Extinguishers

CODE 0122058

MBK14 - DIP - ABFKNOB - 6

6L
 L: **45cm**, OD: **16mm**, ID: **12mm**
 Dip Tube for **ABF - Wet Chemical Knob**
 Operated Fire Extinguishers

CODE 0122059

MBK14 - DIP - ABFKNOB - 9

9L
 L: **51cm**, OD: **16mm**, ID: **12mm**
 Dip Tube for **ABF - Wet Chemical Knob**
 Operated Fire Extinguishers

CODE 0122056

MBK14 - DIP - FKNOB - 6

6L
 L: **43,5cm**, OD: **16mm**, ID: **12mm**
 Dip Tube for **Foam Knob**
 Operated Fire Extinguishers

CODE 0122057

MBK14 - DIP - FKNOB - 9

9L
 L: **49,5cm**, OD: **16mm**, ID: **12mm**
 Dip Tube for **Foam Knob**
 Operated Fire Extinguishers



CODE 0122065

MBK15 - VENT - PKNOB - 6

6Kg
 Gas Dip Tube for Dry Powder Knob
 Operated Fire Extinguishers

CODE 0122064

MBK15 - VENT - PKNOB - 9

9Kg
 Gas Dip Tube for Dry Powder Knob
 Operated Fire Extinguishers



SPARE PARTS FOR FIRE EXTINGUISHERS AND FIRE SUPPRESSION SYSTEMS

FOAM FILTER FOR STORED PRESSURE AND LOCAL APPLICATION FIRE EXTINGUISHERS



CODE 0106037

MBK13 - FILTER - FE

ID: 16mm

Filter for Dip Tube of Portable Foam / Water Stored Pressure Fire Extinguishers 1 - 9Lt without Thread.
Heavy Duty Plastic.



CODE 0106016

MBK13 - WN - FILTER

L: 3cm, OD: 18mm, ID: 14mm

Filter for Dip Tube of Portable Foam / Water Stored Pressure Fire Extinguishers 1 - 9Lt with Thread.
Heavy Duty Plastic.



CODE 0106021

KX09 - 004 - 95

Filter for Dip Tube of Trolley Foam Stored Pressure Fire Extinguishers 25Lt / 50Lt / 100Lt , 3/4" BSP.

DUAL CAST BRAZEN UNIONN

For Local Application Fire Extinguishers

With Special Constructed Thread
 for Easier and Safe Removal.
No more Propellant Gas Leakage.

FILLING VALVE IS NOT INCLUDED



With Safety Bursting Disk!



CODE 0113164

KX02 - 119 - 00B

6Kg / 9Kg / 12Kg & 6Lt / 9Lt

M30 x 1,5mm

with 2 Outlets G^{1/2}"



CODE 0113172

KX02 - 119 - 00C

G1"

25Kg / 50Kg & 25Lt / 50Lt

with 2 Outlets G^{3/4}"

SINGLE OUTLET NIPPLE

For Local Application Fire Extinguishers



CODE 0113003

KX09 - 003 - 143

6Kg / 9Kg / 12Kg & 6Lt / 9Lt

M30 x 1,5mm

with Outlet G^{1/2}"

CODE 0113001

KX09 - 003 - 143A

G1"

25Kg / 50Kg & 25Lt / 50Lt

with Outlet G^{3/4}"



SPARE PARTS FOR FIRE EXTINGUISHERS AND FIRE SUPPRESSION SYSTEMS

BALL VALVE

1/2" or 3/4" Stainless Steel (SS316) Cast (without welding) High Pressure Ball Valve.

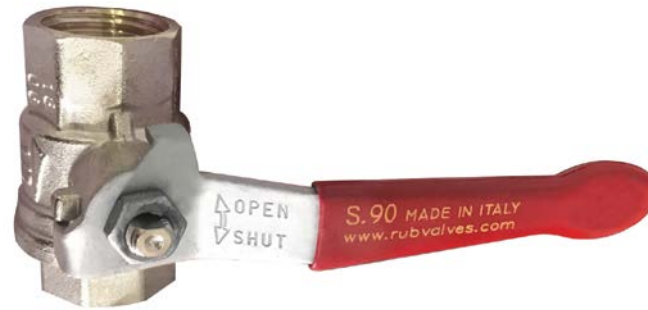

CODE 0112038

KX06 - 003I - 00B

G^{1/2}"
6Kg / 9Kg / 12Kg & 6Lt / 9Lt

CODE 0112044

KX06 - 03J1 - 00A

G^{3/4}"
25Kg / 50Kg & 25Lt / 50Lt

BRAZZEN NIPPLE 1/2"



CODE 0113138

MBK06 - TZ - 1/2

Male Thread at Both Ends, Adjusted to 1/2" **Ball Valve** (KX06-003I-00B) for Changing the Thread from Female to Male in Order to Adjust on it the Flexible Hose KX09 - 007 - 30A (page 48).

CHARGING VALVE



CODE 0111000

KX09 - 003 - 124

For Local Application
Fire Extinguishers and Automatic Ceiling
Fire Extinguishers

THREAD GLUE



CODE 0401044

MBK09 - A1042

200ml
For Assembling and Sealing Local Application
System Components.

SPARE PARTS FOR FIRE EXTINGUISHERS AND FIRE SUPPRESSION SYSTEMS

FIRE SUPPRESSION SYSTEM FLEXIBLE HOSE

50cm Length, Female thread at Both Ends, Stainless Steel Couplings and Stainless Steel Protective External Weave, Connecting the Valve with the Nozzle Network for Fire Suppression Systems

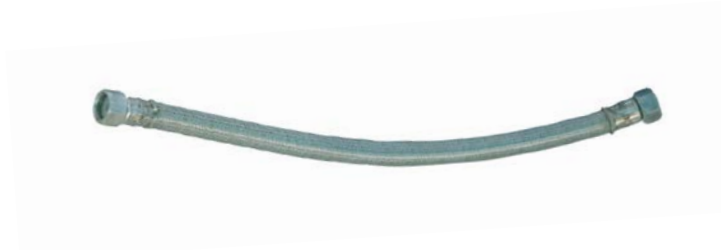

CODE 0102001

MBK13 - SSTUBE - 1/2

21,7 x 1/2"

CODE 0102002

KX09 - 007 - 30A

21,7 x 3/4"

DRY POWDER DISCHARGE NOZZLE

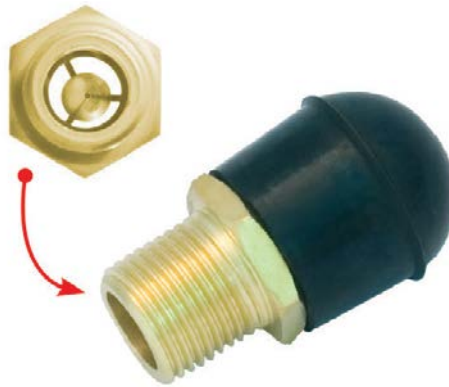

CODE 0130001

MBK13 - NOZZLE - PDR - 1/2

With Plastic Protective Cap, for Dry Powder Fire Suppression Systems.
 Use in Fuel Stations Systems.

CO₂ DISCHARGE NOZZLE

For Fire Suppression Systems



CODE 0130003

KX09 - 004 - 58

1/2"
 Local Flooding. Nickel Plated.



CODE 0130000

KX09 - 004 - 63

1/2"
 Brass.



SPARE PARTS FOR FIRE EXTINGUISHERS AND FIRE SUPPRESSION SYSTEMS

DISCHARGE NOZZLE IG-55 / IG-541

For Fire Suppression Systems



CODE 0119040

KX09 - 041 - 00

1/2"

CODE 0119039

KX09 - 041B - 00

1"

CODE 0119041

KX09 - 041A - 00

3/4"

CODE 0119038

KX09 - 041C - 00

1 1/2"

FIRE SUPPRESSION SYSTEM SPARE PARTS ABF - WET CHEMICAL

ABF-WET CHEMICAL DISCHARGE NOZZLES 1/2"

Protection Cap KX09-004-110-01-09-01
is Included to All the ABF-WET CHEMICAL Discharge Nozzles



CODE 0141089

MBK13 - NOZZLE - A2

Suitable for Fryer, Grill, Electrical
Oven, Extractor Fan



CODE 0141091

MBK13 - NOZZLE - A3

Suitable for Airway Duces,
Charcoal, Wood



CODE 0141092

MBK13 - NOZZLE - A4

Suitable for Oven



CODE 0141093

MBK13 - NOZZLE - A8

Suitable for 4 Points Electrical Oven



CODE 0141090

MBK13 - NOZZLE - A9

Suitable for Fryer and Grill
Plate



CODE 0141111

KX09 - 004 - 110 - 01 - 09 - 01

Silicone protection Cap for the
above mentioned Special Type
Discharge Nozzles



CODE 0141145

MBK16 - KNOZZLE - RTX

Stainless steel with One Discharge Hole x 2.7 mm.
Suitable for All Types of Cooking Devices
Dimensions: Ø13.5 mm x 25 mm
Connection: R¹/₄" Male



NEW

SPARE PARTS FOR FIRE EXTINGUISHERS AND FIRE SUPPRESSION SYSTEMS

THERMOLINKS



CODE 0113203



MBK16 - SRLINK - 141C

Standard Response Thermo Link
Activation Temperature **141° C**

CODE 0113204



MBK16 - SRLINK - 182C

Standard Response Thermo Link
Activation Temperature **182° C**

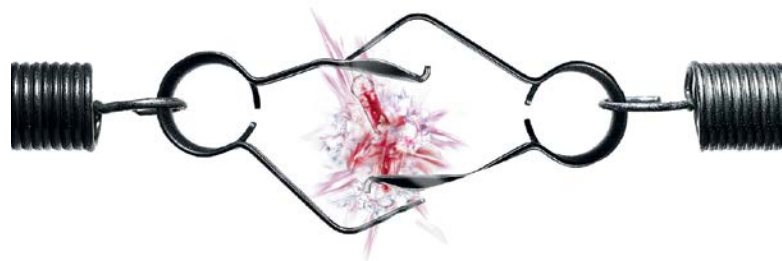

CODE 0113205



MBK16 - SRLINK - 260C

Standard Response Thermo Link
Activation Temperature **260° C**

90° METAL WIRE GUID



CODE 0141096

KX10 - 356 - 02

STAINLESS STEEL WIRE

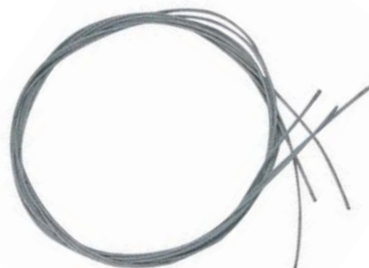

CODE 0141109

MBK10 - WIRE - 316

TAINLESS STEEL 316

STAINLESS STEEL WIRE CLAMP



CODE 0102045

KX09 - 003 - 308

DETECTOR BASE



CODE 0141097

KX10 - 356 - 04



SPARE PARTS FOR FIRE EXTINGUISHERS AND FIRE SUPPRESSION SYSTEMS

FIRE SUPPRESSION SYSTEMS SPARE PARTS ABF - WET CHEMICAL



CODE 0141125

MBK12 - WIRE - 68

Linear Heat Detection Cable
68°C, UL / FM Certified.



CODE 0141120

MBK12 - WIRE - 138

Linear Heat Detection Cable
138°C, UL / FM Certified.



CODE 0141121

MBK12 - WIRE - 180

Linear Heat Detection Cable
180°C, UL / FM Certified.



CODE 0141122

MBK12 - WIRE - 251

Linear Heat Detection Cable
251°C, UL / FM Certified.



CODE 0119235

MBK16 - PTUBE - 6MM - RED

Pneumatic Activation Tube, 6mm
diameter, Red Color, for use in
Pneumatic type Fire Suppression
Systems of All Types.
UL Listed



CODE 0119224

MBK16 - PTUBE - 6MM - GREY

Pneumatic Activation Tube, 6mm
Diameter, Grey Color, for Use
in Pneumatic type Kitchen Fire
Suppression System.



CODE 0102221

MBK12 - CLEMA

Porcelain Splice Connector



CODE 0102223

MBK12 - FIRETAPE

High Durability Thermal
Insulation Tape, **UL Certified**



CODE 0102222

MBK12 - DEMATIKO

Stainless Steel Strap

SPARE PARTS FOR FIRE EXTINGUISHERS AND FIRE SUPPRESSION SYSTEMS

FIRE SUPPRESSION SYSTEMS SPARE PARTS ABF - WET CHEMICAL



CODE **0126046**
KX04 - 001D - 00
 93°C Special Type Sprinkler
 Suitable for **ABF - Wet Chemical**
Fire Suppression Systems



CODE **0126045**
KX04 - 001D - 00A
 141°C Special Type Sprinkler
 Suitable for **ABF - Wet Chemical**
Fire Suppression Systems



CODE **0126047**
KX04 - 013D - 00
 182°C Special Type Sprinkler
 Suitable for **ABF - Wet Chemical**
Fire Suppression Systems



CODE **0126048**
KX04 - 001D - 00B
 260°C Special Type Sprinkler
 Suitable for **ABF - Wet Chemical**
Fire Suppression Systems

FIRE SUPPRESSION SYSTEMS SPARE PARTS ABF - WET CHEMICAL



CODE **0142191**
MBK12 - MOBIAK - DIAS - PANEL

One Zone Control Panel with siren for the Fire Suppression System MOBIAK-DIAS. The panel has Manual System Activation Button, Emergency Cancel Button, factory connected Cables, Schuko plug 220V, ready slots for Fuse Connector and Heat Detection Cable.



CODE **0135270**
MBK12 - TEAM1

Rate - of - Rise Heat Detector - Activator for the Aerosol Fire Suppression System (activation up to 2 aerosol generators or 1 generator A5000).



SPARE PARTS FOR FIRE EXTINGUISHERS AND FIRE SUPPRESSION SYSTEMS

FIRE SUPPRESSION SYSTEMS SPARE PARTS ABF - WET CHEMICAL



CODE 0134041

MBK14 - REMOTE - MOBIAK - DIAS

Remote Activation Mechanical Handle for the Fire Suppression System MOBIAK-DIAS, ACHILLES and other Systems with Automatic Valve



CODE 0141065

MBK10 - FD576

Position Switch



CODE 0142024

MBK10 - FC - PANEL

One Zone control panel with Built-in Battery, Optical Beacon and System Activation Button for ACHILLES Fire Suppression System.



CODE 0141108

MBK10 - PRESS

Pressure Switch

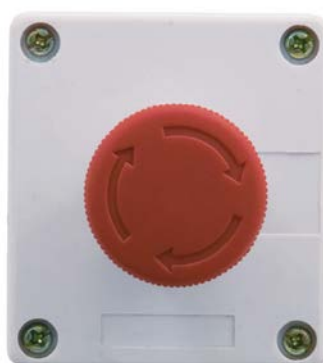

CODE 0142152

MBK10 - CANCEL - BUTTON

Fire Suppression Cancel Button.

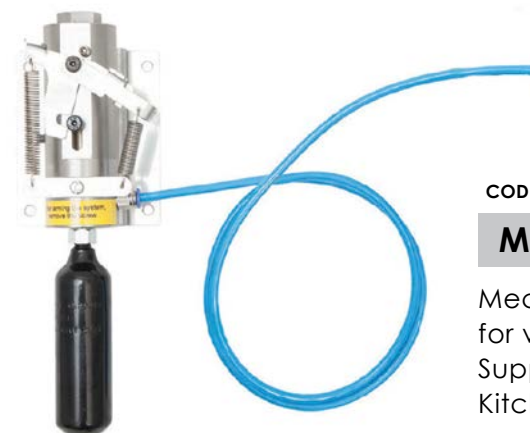

CODE 0119227

MBK15 - ACTUATOR - MEC

Mechanical Activator with Cartridge for valves of Local Application Fire Suppression Systems, such as Achilles Kitchen Fire Suppression System.



CODE 0102301

MBK19 - LAMP - PANEL

Testing Lamp



STAND ALONE SMOKE DETECTORS



CODE 0142199

MBK13 - PW - 507S

Stand Alone Photoelectric Smoke Detector
 with 9V Battery Included and Test Button
 for Verifying the Proper Functioning of the
 Device.



5 Years Guarantee



CODE 0142280



MBK18 - G508 - VDS

CODE 0142275



MBK18 - G508 - NF

- Stand Alone Photoelectric Smoke Detector
- Non Replaceable (built- in) 3V lithium Battery
- Conforms to AS3786:2014 Standard
- 10 Years Long Life Time
- Flash Alarm Indicator (red)
- Photoelectric Chamber for Easily Detect
- Big Test Button for Easy Testing Operation
- Loud>85dB(A) Alarm Signal @3M
- Low Battery Detection / Warning
- Fault Warning
- Easy to Install with Mounting Bracket
- Silence Function Hush Time: 10 Minutes
- Size: Ø100*35.1MM



3 Years Guarantee



STAND ALONE SMOKE DETECTORS

SPARE PARTS FOR FIRE EXTINGUISHERS AND FIRE SUPPRESSION SYSTEMS



CODE 0142276



MBK18 - GS - 528

- DC 9V Battery Operated
- Conforms to AS 3786:2014 Standard
- Flash Alarm Indicator (red circle)
- Loud >85dB(A) Alarm Signal @3M
- Low Battery Signal Alarm
- Test Button for Easy Recommended Monthly Testing
- Safety Clip Feature, Not Allow Mounting of Smoke Alarm without Battery Installed
- Ceiling Mounting
- Easy to Install with Mounting Bracket
- **10 Years Life Time**



3 Years Guarantee



CODE 0142277



MBK18 - GS - 506

- DC 9V Battery Operated
- Photoelectric Chamber for Early Detection from all Directions.
- Loud >85dB(A) Alarm Signal @3M
- Flash Alarm Indicator (red LED)
- Test Button for Easy Recommended Monthly Testing
- Low Battery Signal
- Safety Clip Feature, Not Allow Mounting without Battery Installed
- Ceiling Mounting
- Easy to Install with Mounting Bracket
- 5 Years Lifetime Battery
- **10 Years Life Time**



3 Years Guarantee



INSTRUCTION SIGNS

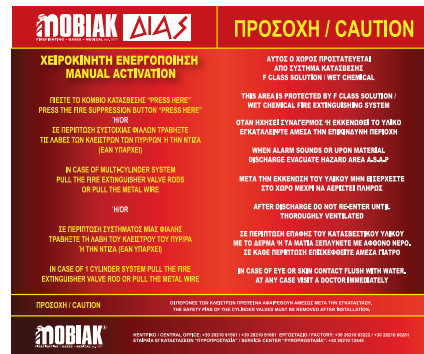

CODE **0149033**

MBK13 - MOBIAK - DIAS - INS

Instruction Sign for **MOBIAK-DIAS, ANPI certified** Fire Suppression System.

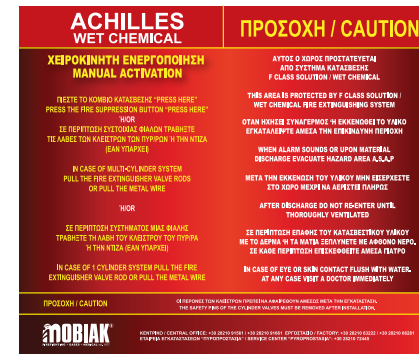

CODE **0149018**

MBK13 - ACHILLES - INS

Instruction Sign for **ACHILLES** Fire Suppression System.



CODE **0149043**

MBK14 - GASSTATION - INS

Instruction Sign for **Dry Powder** Fire Suppression Systems for Petrol Stations.



CODE **0149019**

MBK13 - PROMETHEUS - INS

Instruction Sign for **MOBIAK PROMETHEUS** Fire Suppression System.



CODE **0149020**

MBK11 - IGCO2 - INS

Instruction Sign for **CO2 / IG-541 / IG-55** Fire Suppression System.



CODE **0149117**

MBK19 - HFC227 - INS

Instruction Sign for **HFC-227ea** Fire Suppression System.

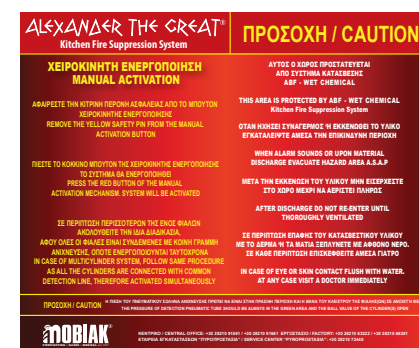

CODE **0149118**

MBK19 - ALEXGR - INS

Instruction Sign for **MOBIAK - Alexander the Great** Fire Suppression System.



SPARE PARTS FOR FIRE EXTINGUISHERS AND FIRE SUPPRESSION SYSTEMS

INSTRUCTION SIGNS

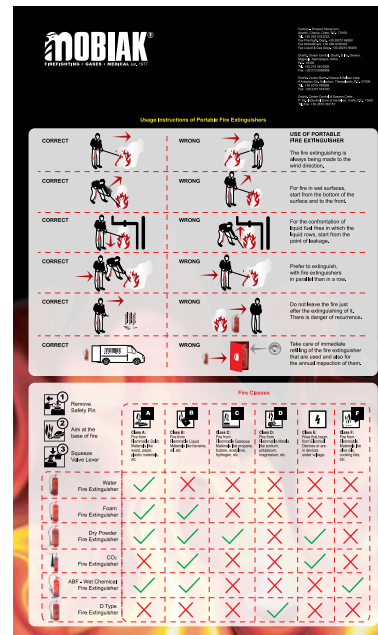

CODE 0149034

MBK13 - FIRE - INS

Instruction Sign for **Portable Fire Extinguishers, in Greek Language.**

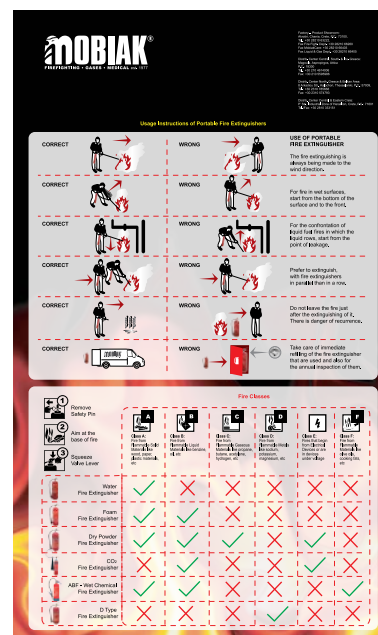

CODE 0149058

MBK17 - FIRE - INS - ENG

Instruction Sign for **Portable Fire Extinguishers, in English Language.**

SPRINKLERS

ALL UL SPRINKLERS ARE ALSO
AVAILABLE IN QUICK RESPONSE UPON
SPECIAL ORDER

PENDENT

SPRINKLERS ARE
INSTALLED
BELOW THE PIPES.

UPRIGHT

SPRINKLERS ARE
INSTALLED
ABOVE THE PIPES



CODE 0126001

KX04 - 001 - 00

Nickel plated, 1/2", 68°C

K: 80,6 PENDENT / UPRIGHT



CODE 0126011

KX04 - 018 - 00

Nickel plated, 1/2", 68°C

K: 80,6 PENDENT



CODE 0126003

KX04 - 002A - 00

Nickel plated, 1/2", 68°C
High Pressure.

K: 80,6 PENDENT



SPARE PARTS FOR FIRE EXTINGUISHERS AND FIRE SUPPRESSION SYSTEMS

SPRINKLERS

ALL UL SPRINKLERS ARE ALSO
AVAILABLE IN QUICK RESPONSE UPON
SPECIAL ORDER

PENDENT

SPRINKLERS ARE
INSTALLED
BELOW THE PIPES.

UPRIGHT

SPRINKLERS ARE
INSTALLED
ABOVE THE PIPES



CODE 0126059

KX04 - 002A - 00 - WHITE

White, 1/2", 68°C, High Pressure
K: 80,6 PENDENT



CODE 0126051

MBK10 - RECESSED

Recessed Sprinkler 68°C ,
3/4" **UL / FM CERTIFIED**
Used in Spaces with Ceiling Roof



CODE 0126052

MBK10 - DH80

PENDENT 68°C
3/4" **UL Listed**

**Double Coverage Ability
Comparing to a Common
Sprinkler (Can Cover Areas
of 9m Length and 5m Width)**

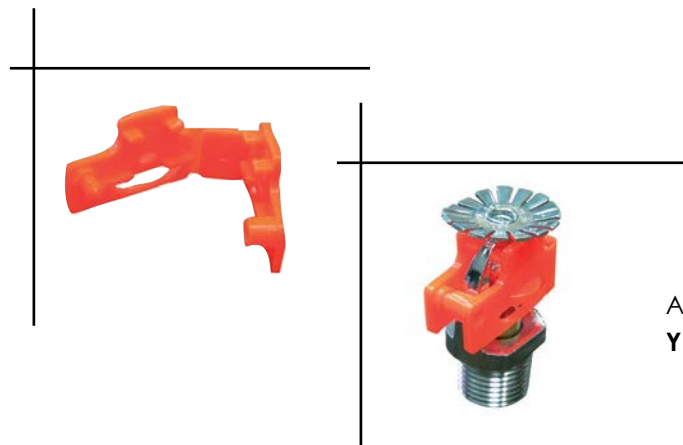

ALL SPRINKLERS ARE PROVIDED WITH A PLASTIC PROTECTIVE CASE.
YOU HAVE TO REMOVE IT AFTER INSTALLATION.

STANDARD RESPONSE

CODE **0126064**

MBK19-SR-UPRIGHT-57C

Upright Sprinkler - K 80 - Standard Response - Brass or Chrome - NPT 1/2" or R1/2" - 57°/135°F

CODE **0126065**

MBK19-SR-UPRIGHT-68C

Upright Sprinkler - K 80 - Standard Response - Brass or Chrome - NPT 1/2" or R1/2" - 68°/155°F

CODE **0126066**

MBK19-SR-UPRIGHT-79C

Upright Sprinkler - K 80 - Standard Response - Brass or Chrome - NPT 1/2" or R1/2" - 79°/175°F

CODE **0126067**

MBK19-SR-UPRIGHT-93C

Upright Sprinkler - K 80 - Standard Response - Brass or Chrome - NPT 1/2" or R1/2" - 93°/200°F



UPRIGHT - UL

QUICK RESPONSE

CODE **0126068**

MBK19-QR-UPRIGHT-57C

Upright Sprinkler - K 80 - Quick Response - Brass or Chrome - NPT 1/2" or R1/2" - 57°/135°F

CODE **0126069**

MBK19-QR-UPRIGHT-68C

Upright Sprinkler - K 80 - Quick Response - Brass or Chrome - NPT 1/2" or R1/2" - 68°/155°F

CODE **0126070**

MBK19-QR-UPRIGHT-79C

Upright Sprinkler - K 80 - Quick Response - Brass or Chrome - NPT 1/2" or R1/2" - 79°/175°F

CODE **0126071**

MBK19-QR-UPRIGHT-93C

Upright Sprinkler - K 80 - Quick Response - Brass or Chrome - NPT 1/2" or R1/2" - 93°/200°F



ALL SPRINKLERS ARE PROVIDED WITH A PLASTIC PROTECTIVE CASE. YOU HAVE TO REMOVE IT AFTER INSTALLATION.

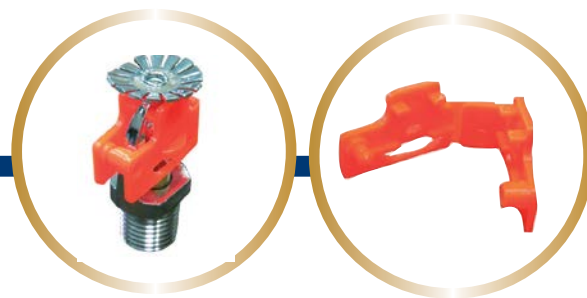

STANDARD RESPONSE

CODE **0126072**

MBK19-SR-CONCEALED-57C

Concealed Sprinkler - Pendant - Standard Response - Brass or Chrome - NPT 1/2" or R1/2" - 57°/135°F

CODE **0126073**

MBK19-SR-CONCEALED-68C

Concealed Sprinkler - Pendant - Standard Response - Brass or Chrome - NPT 1/2" or R1/2" - 68°/155°F

CODE **0126074**

MBK19-SR-CONCEALED-79C

Concealed Sprinkler - Pendant - Standard Response - Brass or Chrome - NPT 1/2" or R1/2" - 79°/175°F

CODE **0126075**

MBK19-SR-CONCEALED-93C

Concealed Sprinkler - Pendant - Standard Response - Brass or Chrome - NPT 1/2" or R1/2" - 93°/200°F



RECESSED - UL

QUICK RESPONSE

CODE **0126076**

MBK19-QR-CONCEALED-57C

Concealed Sprinkler - Pendant - Quick Response - Brass or Chrome - NPT 1/2" or R1/2" - 57°/135°F

CODE **0126077**

MBK19-QR-CONCEALED-68C

Concealed Sprinkler - Pendant - Quick Response - Brass or Chrome - NPT 1/2" or R1/2" - 68°/155°F

CODE **0126078**

MBK19-QR-CONCEALED-79C

Concealed Sprinkler - Pendant - Quick Response - Brass or Chrome - NPT 1/2" or R1/2" - 79°/175°F

CODE **0126079**

MBK19-QR-CONCEALED-93C

Concealed Sprinkler - Pendant - Quick Response - Brass or Chrome - NPT 1/2" or R1/2" - 93°/200°F





STANDARD RESPONSE

CODE 0126080

MBK19-SR-PENDENT-57C

Pendent Sprinkler - K 80 - Standard Response - Brass or Chrome - NPT 1/2" or R1/2" - 57°/135°F

CODE 0126081

MBK19-SR-PENDENT-68C

Pendent Sprinkler - K 80 - Standard Response - Brass or Chrome - NPT 1/2" or R1/2" - 68°/155°F

CODE 0126082

MBK19-SR-PENDENT-79C

Pendent Sprinkler - K 80 - Standard Response - Brass or Chrome - NPT 1/2" or R1/2" - 79°/175°F

CODE 0126083

MBK19-SR-PENDENT-93C

Pendent Sprinkler - K 80 - Standard Response - Brass or Chrome - NPT 1/2" or R1/2" - 93°/200°F



**PENDENT
SPRINKLERS ARE
INSTALLED BELOW
THE PIPES. UPRIGHT
SPRINKLERS ARE
INSTALLED
ABOVE THE
PIPES**

PENDENT - UL

QUICK RESPONSE

CODE 0126084

MBK19-SR-PENDENT-57C

Pendent Sprinkler - K 80 - Quick Response - Brass or Chrome - NPT 1/2" or R1/2" - 57°/135°F

CODE 0126085

MBK19-SR-PENDENT-68C

Pendent Sprinkler - K 80 - Quick Response - Brass or Chrome - NPT 1/2" or R1/2" - 68°/155°F

CODE 0126086

MBK19-SR-PENDENT-79C

Pendent Sprinkler - K 80 - Quick Response - Brass or Chrome - NPT 1/2" or R1/2" - 79°/175°F

CODE 0126087

MBK19-SR-PENDENT-93C

Pendent Sprinkler - K 80 - Quick Response - Brass or Chrome - NPT 1/2" or R1/2" - 93°/200°F



STANDARD RESPONSE

CODE 0126088

MBK19-SR-HORIZONTAL-57C

Horizontal Sidewall - K 80 - Standard Response - Brass or Chrome - NPT 1/2" or R1/2" - 57°/135°F

CODE 0126090

MBK19-SR-HORIZONTAL-68C

Horizontal Sidewall - K 80 - Standard Response - Brass or Chrome - NPT 1/2" or R1/2" - 68°/155°F

CODE 0126092

MBK19-SR-HORIZONTAL-79C

Horizontal Sidewall - K 80 - Standard Response - Brass or Chrome - NPT 1/2" or R1/2" - 79°/175°F

CODE 0126094

MBK19-SR-HORIZONTAL-93C

Horizontal Sidewall - K 80 - Standard Response - Brass or Chrome - NPT 1/2" or R1/2" - 93°/200°F

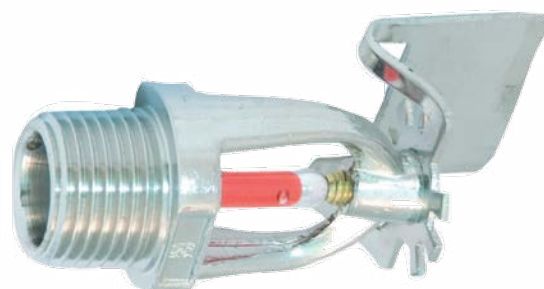

QUICK RESPONSE

CODE 0126089

MBK19-QR-HORIZONTAL-57C

Horizontal Sidewall - K 80 - Quick Response - Brass or Chrome - NPT 1/2" or R1/2" - 57°/135°F

CODE 0126091

MBK19-QR-HORIZONTAL-68C

Horizontal Sidewall - K 80 - Quick Response - Brass or Chrome - NPT 1/2" or R1/2" - 68°/155°F

CODE 0126093

MBK19-QR-HORIZONTAL-79C

Horizontal Sidewall - K 80 - Quick Response - Brass or Chrome - NPT 1/2" or R1/2" - 79°/175°F

CODE 0126095

MBK19-QR-HORIZONTAL-93C

Horizontal Sidewall - K 80 - Quick Response - Brass or Chrome - NPT 1/2" or R1/2" - 93°/200°F



SPRINKLERS

ALL UL SPRINKLERS ARE ALSO
 AVAILABLE IN QUICK RESPONSE UPON
 SPECIAL ORDER

PENDENT

SPRINKLERS ARE
 INSTALLED
 BELOW THE PIPES.

UPRIGHT

SPRINKLERS ARE
 INSTALLED
 ABOVE THE PIPES



CODE 0126029

KX04 - 019 - 00

Nickel Plated, 1/2", 68°C
 K: 80,6 UPRIGHT



CODE 0126002

KX04 - 001A - 00

Nickel Plated, 1/2", 93°C
 K: 80,6 PENDENT



CODE 0126000

KX04 - 001B - 00

Nickel Plated, 1/2", 141°C
 K: 80,6 PENDENT / UPRIGHT



CODE 0126032

KX04 - 013A - 00A

Nickel plated, 1/2", 182°C
PENDENT
 FOR BARBEQUE - CHARCOAL GRILLS
 High Temperature Cooking Facilities

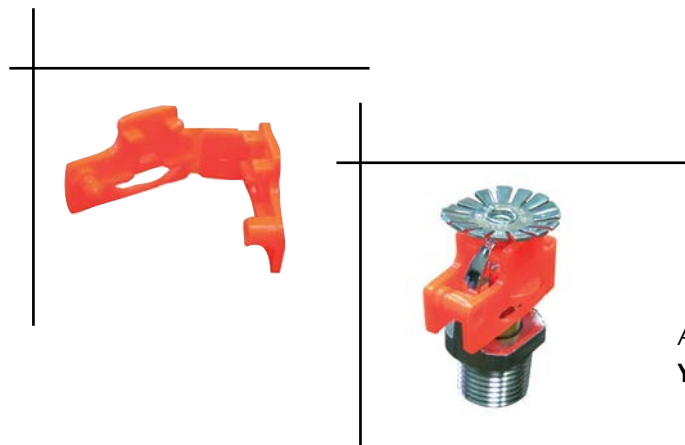

ALL SPRINKLERS ARE PROVIDED WITH A PLASTIC PROTECTIVE CASE.
 YOU HAVE TO REMOVE IT AFTER INSTALLATION.



SPARE PARTS FOR FIRE EXTINGUISHERS AND FIRE SUPPRESSION SYSTEMS

SPRINKLERS

PENDENT

SPRINKLERS ARE
INSTALLED
BELOW THE PIPES.

UPRIGHT

SPRINKLERS ARE
INSTALLED
ABOVE THE PIPES



CODE 0126033

KX04 - 013A - 00B

Brazen $\frac{1}{2}$ " **260°C**
PENDENT
FOR BARBEQUE - CHARCOAL GRILLS
High Temperature Cooking Facilities



CODE 0126004

KX04 - 029 - 00

Open Type Nickel Plated, $\frac{1}{2}$ "



CODE 0126006

KX04 - 023 - 00

$\frac{1}{2}$ "
K: 80,6 Recessed Sprinkle 68°C
Suitable for Fake Ceilings.
Non Visible for Aesthetic Reasons.



ALL SPRINKLERS ARE PROVIDED WITH A PLASTIC PROTECTIVE CASE.
TO BE REMOVED UPON INSTALLATION

SPRINKLER

PENDENT

SPRINKLERS ARE
 INSTALLED
 BELOW THE PIPES.

UPRIGHT

SPRINKLERS ARE
 INSTALLED
 ABOVE THE PIPES



CODE 0126042

KX04 - 007J - 00

M30 x 1,5mm
 Sprinkler 68°C with Safety Valve
 and Place for **CE certified (TUV)**
 Pressure Gauge. For Automatic Fire
 Extinguishers

CE (TUV)

**SPRINKLER CE CERTIFICATE
 UNDER MOBIAK BRAND**

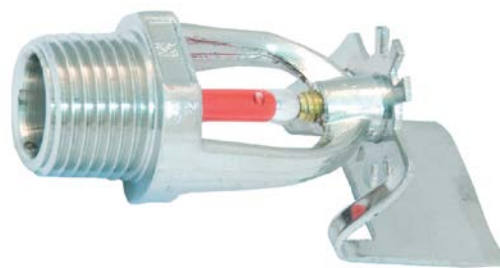

CODE 0126009

KX04 - 021 - 00

Nickel, 1/2",
 K: 80 Wall Mounted Sprinkler 68°C.



CODE 0126007

KX04 - 022 - 00

M30 x 1,5mm
 With **Metallic Base 68°C**
 for Special Applications

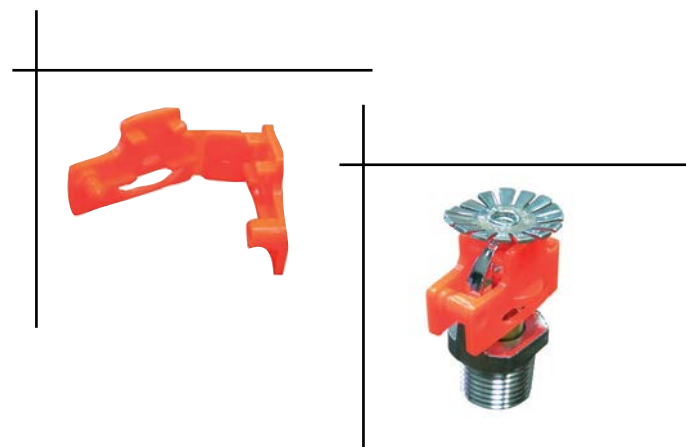

ALL SPRINKLERS ARE PROVIDED WITH A PLASTIC PROTECTIVE CASE.
 TO BE REMOVED UPON INSTALLATION



SPARE PARTS FOR FIRE EXTINGUISHERS AND FIRE SUPPRESSION SYSTEMS

SPRINKLER

PENDENT

SPRINKLERS ARE
INSTALLED
BELOW THE PIPES.

UPRIGHT

SPRINKLERS ARE
INSTALLED
ABOVE THE PIPES



CODE 0126012

KX15 - FES - ZTP10

K: 30 FOAM 1/2"

Special Sprinkler
for use in Warehouses
or Other Rooms with
Height Up to
13m and Coverage Up
to 9,3m²



CODE 0126055

MBK11 - ESFR - UPRIGHT

3/4"

K: 200 68°C UPRIGHT

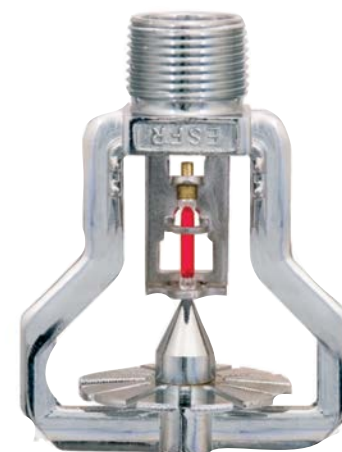

CODE 0126053

MBK10 - ESFR

3/4"

K: 200 PENDENT 68°C

PROTECTIVE COVERS FOR SPRINKLERS



CODE 0126017

KX10 - 168A - 00

For Ceiling Fire Extinguishers Without
Conical Hoop or for Sprinkler Networks.

ROSETTE



CODE 0126018

KX10 - 121 - 00

Recessed for Sprinklers



CODE 0126020

KX10 - 117 - 00

Wall mounted for Sprinklers



CODE 0126057

MBK12 - ROSETTE - WHITE

White, Wall Mounted for Sprinklers 1/2"



SPARE PARTS FOR FIRE EXTINGUISHERS AND FIRE SUPPRESSION SYSTEMS

MANIFOLD TEE - GALVANIZED

WP 200bar PT 300bar



CODE 0127018

KX09 - 003 - 167

1 1/4" x 1 1/4" x 3/4"

CODE 0127020

KX09 - 003 - 167A

2" x 2" x 3/4"

CODE 0127019

KX09 - 003 - 167B

2 1/2" x 2 1/2" x 3/4"

CODE 0127021

KX09 - 003 - 167C

3" x 3" x 3/4"

MANIFOLD TUBE - GALVANIZED

WP 200bar PT 300bar



300 bar Manifold Test Certificate by MIRTEC S.A.

CODE 0127010

KX09 - 003 - 166

1 1/4"

CODE 0127012

KX09 - 003 - 166A

2"

CODE 0127011

KX09 - 003 - 166B

2 1/2"

CODE 0127013

KX09 - 003 - 166C

3"

MANIFOLD CAP - GALVANIZED

WP 200bar PT 300bar



CODE 0127014

KX09 - 003 - 168

1 1/4"

CODE 0127016

KX09 - 003 - 168A

2"

CODE 0127015

KX09 - 003 - 168B

2 1/2"

CODE 0127017

KX09 - 003 - 168C

3"

MANIFOLD REDUCING COUPLING GALVANIZED

WP 200bar PT 300bar



CODE 0127006

KX09 - 003 - 169

1 1/4" x 3/4"

CODE 0127008

KX09 - 003 - 169A

2" x 1"

CODE 0127007

KX09 - 003 - 169B

2 1/2" x 1 1/2"

CODE 0127009

KX09 - 003 - 169C

3" x 2"

NON RETURN VALVE



CODE 0108002

KX06 - 082 - 00

3/4" x 3/4" for

CO₂ / IG-541 / IG-55 Fire Suppression Systems. Installed between the Flexible Hose and the Manifold.

FLEXIBLE HOSE

WP 200bar



CODE 0102034

MBK04 - 007 - 45B

21,78 x 3/8" (Female Thread at Both Ends) For Connecting the Pilot Cylinder Valve to the First High Pressure Cylinder Valve of a IG-541 / IG-55 / CO₂ Fire Suppression System (Multiple Cylinder Systems - Batteries).

L: 52cm

PT 300bar

CODE 0102035

MBK04 - 007 - 45

3/8" x 3/8" (Female thread at both ends) for connecting the Cylinder Pneumatic Valves of a IG-541 / IG-55 / CO₂ Fire Suppression System with Each Other (Multiple Cylinder Systems - Batteries).

L: 53cm

PT 300bar



SPARE PARTS FOR FIRE EXTINGUISHERS AND FIRE SUPPRESSION SYSTEMS

COUPLING



CODE 0124015

KX09 - 003 - 170

3/8"x 3/8" for connecting **CO₂ Valves with the Flexible Hoses** that Connect the Cylinders of CO₂ IG Fire Suppression System.

FLEXIBLE HOSE

WP 200bar

**FLEXIBLE HOSES CAN
BE MANUFACTURED
IN VARIOUS LENGTHS
UPON SPECIAL REQUEST**



CODE 0102003

MBK04 - 007 - 45C

21,78 x 3/4" (Female Thread at Both Ends) For **Connecting the Cylinders of a IG-541 / IG-55 / CO₂ Fire Suppression System to the Manifold** (Multiple Cylinder Systems). L: **53cm**
PT 300bar

CODE 0102036

MBK04 - 007 - 45A

21,78 x 1/2" (Female Thread at Both Ends) For **Connecting the Cylinders of a IG-541 / IG-55 / CO₂ Fire Suppression System to the Nozzle Network** (Multiple Cylinder Systems).
L: **50cm**
PT 300bar

WASHER



CODE 0124026

KX10 - 085A - 00

21,7mm (18,6 x 12,3 x 1,6mm). Fitted on the Outlet of the Suppression System Cylinder Valve, at the Link Point of the Flexible Hose and the Connector / Discharge Nozzle Network.

CODE 0124025

KX10 - 085B - 00

3/8" (15 x 6,5 x 1,5mm). Fitted on Flexible Hoses, Connecting Fire Suppression System **CO₂ / IG-541 / IG-55** Cylinders with Each Other, Ensuring the Sealing of The Connection.

CODE 0124028

KX10 - 085C - 00

1/2" (19,8 x 12,5 x 1,6mm). Fitted on the Flexible Hoses, Connecting a Single Cylinder of a Fire Suppression Dry Powder or **CO₂ / IG-541 / IG-55** System, with the Discharge Nozzle Network, Ensuring the Sealing of the Connection

HANGING WEIGHING DEVICE



CODE 0127053



MBK18 - WD - HGTYPE

Maximum Gross Weight 170Kg
Hanging Weighing Device
CO₂ / IG541 / IG55 Bottle Systems

CE 0068

FLOOR TYPE CYLINDER WEIGHTING DEVICE



CODE 0127052



MBK18 - WD - FLTYPE

Maximum Gross Weight 121Kg
Weighting Machine Floor Type for
CO₂ / IG541 / IG55 Fire Suppression Systems
with Switch for Monitoring the System

CE



SPARE PARTS FOR FIRE EXTINGUISHERS AND FIRE SUPPRESSION SYSTEMS

HANGING WEIGHING DEVICE



CODE 0127027

MBK04 - S - 015MB

MAXIMUM MIXED WEIGHT 180kg Hanging Weighing Device
CO₂ / IG541 / IG55 Systems Bottle with "EMPTY" / "FULL" Indication.
Supplied with Bottle Adapter.

Photography Explanation:

1. Weighing
2. Switch
3. Adapter

Switch Monitoring the System
CO₂ / IG-541 / IG-55 (see photo, accessory 2).

MOUNTING BASE - WEIGHING DEVICE OF PORTABLE CO₂ FIRE EXTINGUISHERS



The Mounting Base - Weighing Device of **2Kg / 5Kg CO₂** Portable Fire Extinguisher is Activated by Placing the Fire Extinguisher on the Retaining Pin. When the Fire Extinguisher is empty, then the Indication, will be **EMPTY, with Red Color.**

When the Fire Extinguisher is filled with **CO₂**, then the Indication will be **FULL, with Green Color.**

CODE 0114098

MBK15-BRWEIGHT-2

2Kg CO₂

CODE 0114099

MBK15-BRWEIGHT-5

5Kg CO₂



Value in safety... Invest in Quality!!



SPARE PARTS FOR FIRE EXTINGUISHERS AND FIRE SUPPRESSION SYSTEMS

BRACKETS FOR FIRE EXINGUISHERS

Metallic Bracket for Fire Extinguishers
Electrostatic Coating, Plastic Cover at the Edges for
Protection of the Extinguisher Cylinders.

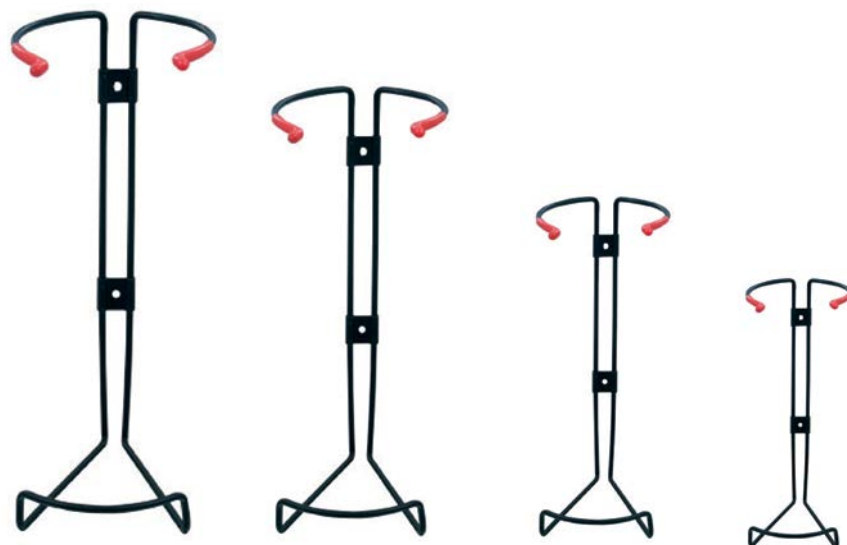

CODE 0114058

KX09 - 016 - 02C1

1Kg / 1Lt

CODE 0114060

KX09 - 016 - 03E

3Kg / 3Lt

CODE 0114059

KX09 - 016 - 03D

2Kg / 2Lt

CODE 0114072

KX09 - 016 - 78 - NEW

6Kg / 6Lt

Metallic Bracket for Fire Extinguishers
Electrostatic Coating, Plastic Cover at the
Edges for Protection of the Extinguisher
Cylinders.



CODE 0114064

KX09 - 013 - 37

6Kg & 6Lt

Wall Bracket for Fire Extinguishers



CODE 0114065

KX09 - 013 - 37A

9Kg / 12Kg & 9Lt

Wall Bracket for Fire Extinguishers



CODE 0114066

KX09 - 013 - 37B

2Kg

Wall Bracket for Fire Extinguishers



CODE 0114067

KX09 - 013 - 37C

5Kg

Wall Bracket for Fire Extinguishers CO₂.

MAGNETIC BRACKET FOR FIRE EXTINGUISHERS



NEW

CODE 0114116

MBK18 - SUPPORT - MAGNET

6Kg / 9Kg / 12Kg & 6Lt / 9Lt & 2Kg / 5kg CO₂
Metallic Bracket for Various Portable Fire
Extinguishers, for Metallic Surfaces.
Quick Installation of the Fire Extinguisher

(Extinguisher Bracket is Not Included).





SPARE PARTS FOR FIRE EXTINGUISHERS AND FIRE SUPPRESSION SYSTEMS

PLASTIC FIRE EXTINGUISHER



CODE 0114010

KX09 - 016 - 30C

1Kg / 1Lt

Φ90, For Steel and Stainless Steel Fire Extinguisher



CODE 0114008

KX09 - 016 - 30B1

2Kg / 2Lt

Φ105, For Stainless Steel Fire Extinguisher



CODE 0114004

KX09 - 016 - 30A1

2Kg / 2Lt

Φ110, For Steel Fire Extinguisher



CODE 0114009

KX09 - 016 - 33A

3Kg / 3Lt

Φ130, For Steel and Stainless Steel
Fire Extinguisher

WALL BRACKETS



CODE 0114088

MBK13 - BRACKET - RING

Wall Mounted **Metallic Bracket** for Below Metallic Rings.

METALLIC RINGS



CODE 0114089

MBK13 - RING - 6

6Kg / 6Lt
Φ160
 Metallic ring for Dry Powder / Foam / ABF Wet - Chemical Fire Extinguisher.

CODE 0114090

MBK13 - RING - 9/12

9Kg / 12Kg & 9Lt
Φ180
 Metallic ring for Dry Powder / Foam / ABF Wet - Chemical Fire Extinguishers.

CODE 0114092

MBK13 - RING - 5H

5Kg CO₂
Φ152
 Metallic Ring for Fire Extinguisher (MBK06 - 050CA - P1D).

CODE 0114093

MBK13 - RING - 2H

2Kg CO₂
Φ114
 Metallic Ring for Fire Extinguisher (KX11 - 532 - AO & KX11 - 532 - AOR).

CODE 0114091

MBK13 - RING - 5L

5Kg CO₂
Φ138
 Metallic Ring for Fire Extinguisher (MBK02 - 050CA - P1A).

CODE 0114094

MBK13 - RING - 2L

2Kg CO₂
Φ105
 Metallic Ring for Fire Extinguisher (MBK12 - 020CA - P1A).

WALL BRACKETS

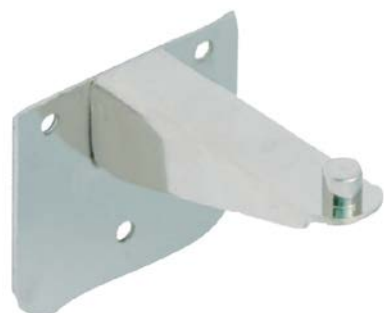

CODE 0114061

KX09 - 013 - 04E

6 Kg & 6Lt
High Strength Bracket
 for Fire Extinguisher



CODE 0141008

KX09 - 013 - 21N

6Kg / 9Kg / 12Kg & 6Lt - 9Lt & 2Kg / 5Kg CO₂
Plastic High Strength Bracket
 for Fire Extinguisher (Suitable for External)
 Use in Rough Weather Conditions
 (e.g: Near the Sea).

CODE 0114079

MBK10 - BRACKET - 12

9Kg / 12Kg & 9Lt
High Strength Bracket
 for Fire Extinguisher



CODE 0141009

KX10 - 176 - 00

6Kg / 9Kg / 12Kg & 6Lt / 9Lt & 2Kg / 5Kg
Protective Pad for Fire Extinguishers
 Used when Hanging the Fire Extinguisher to the Wall for Protecting the Vessel and the Wall from Damage.



SPARE PARTS FOR FIRE EXTINGUISHERS AND FIRE SUPPRESSION SYSTEMS

BRACKET ADAPTORS



CODE 0114107



MBK16 - SBRACKET - CARTR6

6Kg / 6Lt

Fire Extinguisher Bracket Adaptor Special Type for Already Installed Wall Brackets (wall part is not included).

CODE 0114108



MBK16 - SBRACKET - CARTR9

9Kg & 12Kg / 9Lt

Fire Extinguisher Bracket Adaptor Special Type for Already Installed wall Brackets. (wall part is not included)

SECURITY ALARM



CODE 0133001

MBK02 - DOLPHIN

Security Alarm - Bracket for Dry Powder, Foam, Water, ABF - Wet Chemical and CO₂ Fire Extinguishers (requires a 9V battery.) Activated when the Fire Extinguishers is Removed from the Bracket by an Unauthorized Person. Deactivated when Authorized Personnel Inserts Pin into the Bracket. Battery is Not Included.

CODE 0133043

MBK14 - ALARM

Security Alarm for Dry Powder, Foam, Water, ABF - Wet Chemical and CO₂ Fire Extinguishers (requires a 9V battery). Activated when the Fire Extinguisher is removed from its Position and the Cable is Disconnected to the Alarm. Deactivated when the Fire Extinguisher and Therefore the Cable, is Placed Back in its Original Position. Battery is not Included.



FLOOR TYPE BASE



CODE 0114069

KX09 - 016 - 44

6Kg / 9Kg / 12Kg & 6Lt / 9Lt & 2Kg / 5Kg CO₂

With Fire Extinguisher Indication Sign.
 Hanging from the **Vessel**.



CODE 0114101

MBK15 - BASE - LABEL

6Kg / 9Kg / 12Kg & 6Lt / 9Lt / 12Lt & 2Kg / 5Kg CO₂

With Fire Extinguisher Indication Sign. Hanging from the **Vessel**



CODE 0114100

MBK15 - BASE - SUP

6Kg / 9Kg / 12Kg & 6Lt / 9Lt / 12Lt & 2Kg / 5Kg CO₂

Hanging from the **Vessel**.



CODE 0114102

MBK15 - BASE - PLAS

6Kg / 9Kg & 6Lt / 9Lt & 5Kg CO₂

Plastic, Floor Type Base of Fire Extinguisher, High Quality, **with capability to be Wall Mounted!**



CODE 0114129



NEW

MBK19-BASE-SKNOB

Silver Plastic Floor Stand with Fire Extinguisher Mark for hanging from **Cylinder**.



CODE 0114128



NEW

MBK19-BASE-SVAL

Silver Plastic Floor Stand with Fire Extinguisher Mark for Hanging from **Valve**.



CODE 0114127



NEW

MBK19-BASE-BKNOB

Black Plastic Floor Stand with Fire Extinguisher Mark for Hanging from **Cylinder**.



CODE 0114126



NEW

MBK19-BASE-BVAL

Black Plastic Floor Stand with Fire Extinguisher Mark for Hanging from **Valve**.



SPARE PARTS FOR FIRE EXTINGUISHERS AND FIRE SUPPRESSION SYSTEMS

FLOOR TYPE BASE



CODE 0114076

MBK10 - SUPPORT - CHROMIUM

6Kg / 9Kg / 12Kg & 6Lt / 9Lt & 2Kg / 5Kg CO₂
Floor Type Chrome Base. Hanging from the **Vessel**.



CODE 0114119

MBK19 - CHROMEbase - DB

6Kg / 9Kg / 12Kg & 6Lt / 9Lt & 2Kg / 5Kg CO₂
Double Floor type Chrome Base. Hanging from the **Valve**.



NEW



CODE 0114070

KX09 - 016 - 84

6Kg / 9Kg / 12Kg & 6Lt / 9Lt &
2Kg / 5Kg CO₂
Double Floor Type Base.
Hanging from the **Valve**.



CODE 0119346

MBK18 - BASE - KNOB

6Kg / 9Kg / 12Kg & 6Lt / 9Lt
Single Floor Type Base.
Hanging from **Vessel**.



NEW

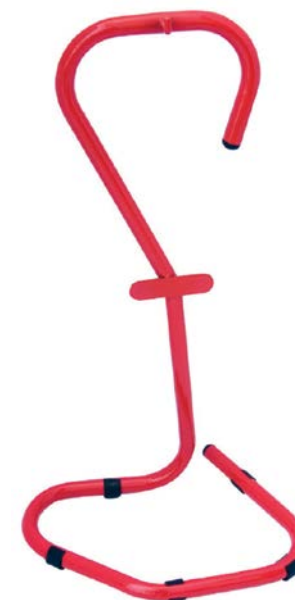

CODE 0114037

KX09 - 016 - 45

6Kg / 9Kg / 12Kg & 6Lt /
9Lt & 2Kg / 5Kg CO₂
Single Floor Type Base.
Hanging from **Valve**.

BRACKET FOR FIRE EXTINGUISHERS

Metallic Bracket with Internal lining and **Stainless Steel Screws** for Quick Instalation. **Electrostatic Coating.**
 For Horizontal and Vertical Installation.



CODE 0114063

KX09 - 016 - 48C

6Kg & 6Lt

CODE 0114068

KX09 - 016 - 48D

9Kg / 12Kg & 9Lt / 19Lt

BRACKET FOR FIRE EXTINGUISHERS

Metallic Bracket with Internal Lining and **Stainless Steel Screws** for Quick Instalation. **Electrostatic Coating.**
 For Horizontal and Vertical Installation.



Belt

CODE 0114073

KX09 - 016 - 08A

6Kg & 6Lt

Safety Belt is Included.



Belt

CODE 0114074

KX09 - 016 - 08B

9Kg / 12Kg & 9Lt / 19Lt

Safety Belt is Included.



SPARE PARTS FOR FIRE EXTINGUISHERS AND FIRE SUPPRESSION SYSTEMS

PILOT CYLINDER BRACKET

Metallic Bracket for Pilot Cylinder of Fire Suppression System with Internal Protective Lining and Stainless Steel Screws for Quick Installation. Electrostatic Coat. **Suitable for Extinguishers 2Kg CO₂.**



CODE 0114011

KX09 - 016 - 48

2Kg CO₂
Pilot Cylinder Bracket.

HEAVY DUTY BRACKET

Galvanized Bracket with Internal Protective Pads. Adjustable Width Fitting to Various Capacities. Electrostatic Coating. Suitable for Use to Trucks or Walls. A Good Choice for **Dry Powder / Foam / Water / ABF - Wet Chemical Fire Suppression System Fire for Horizontal and Vertical Installation.**



CODE 0114002

MBK13 - HDBRACKET - 6

6Kg & 6Lt & 5Kg CO₂

CODE 0114001

MBK13 - HDBRACKET - 12

9Kg / 12Kg & 9Lt / 19Lt

PORTABLE FIRE EXTINGUISHER BRACKET



CODE 0114097

MBK15 - HDBRACKET - 6 - 19

6Kg / 9Kg / 19Kg & 6Lt / 9Lt / 19Lt & 5kg CO₂

Adjustable - Galvanized Bracket with Inner Plastic Protection for Non-Injury of Vessel. For **6Kg / 9Kg / 19Kg & 6Lt / 9Lt / 19Lt & 5kg CO₂ Vessels.**

Electrostatic Painting. Suitable for Support of Fire Suppression System Extinguisher and Fire Extinguisher of **Dry Powder / Foam / Water / ABF - Wet Chemical.** Horizontal and Vertical Mounting is Possible.

PORTABLE FIRE EXTINGUISHER SET BRACKET AND "T"

PORTABLE FIRE EXTINGUISHER **METALLIC BRACKET AND "T"** WITH POSITION FOR 2 SAFETY BELTS



CODE 0114017

MBK03 - SUPPAF

6Kg / 6Lt
 for Fire Extinguishers with
 Diameter 18cm

CODE 0114018

MBK03 - SUPPAT

9Kg / 12Kg & 9Lt
 for Fire Extinguishers with
 Diameter 20cm

SAFETY BELT



CODE 0117003

KX09 - 006 - 100

6Kg / 9Kg / 12Kg & 6Lt / 9Lt
 Sets in Metallic Bracket



SPARE PARTS FOR FIRE EXTINGUISHERS AND FIRE SUPPRESSION SYSTEMS

CYLINDER BRACKET



For CO₂ or IG-541 / IG-55 Fire Suppression Systems, Internal Plastic Lining for Effective Grip and Additional Protection of the Cylinder. Stainless Steel Butterfly Screws for Quick and Easy Installation. **Electrostatic Coating.**

CODE 0114114



NEW

KX09 - 016 - 46A - 254

Cylinder Bracket of HFC-FK Systems 14,50Lt

CODE 0114033

KX09 - 016 - 47

Cylinder Bracket of 16Lt

CYLINDER BRACKET



CODE 0114103



NEW

KX09 - 016 - 46A - 324

Cylinder Bracket of HFC-FK Systems 32Lt / 50Lt

CODE 0114104



NEW

KX09 - 016 - 46A - 406

Cylinder Bracket of HFC-FK Systems 90Lt / 120Lt / 150Lt

CODE 0114044

KX09 - 016 - 46A

Cylinder Bracket of HFC-FK Systems 67,5Lt / 75Lt / 80Lt

CODE 0114022

KX09 - 016 - 46

Cylinder Bracket of HFC-FK Systems 40Lt / 50Lt



CODE 0114052

KX11 - ACE - ADB

Adjustable Length Bracket with Bolt And Nut for Ceiling Automatic Fire Extinguishers. **Min Length 80cm - Max. Length 150cm.**

PROTECTIVE BOX FOR FIRE EXTINGUISHERS



CODE 0133002

KX06 - 090A - 00

1Kg / 1Lt
 Plastic Protective Box
 Box Dimensions: 390x145x120 mm



CODE 0133035

MBK08 - R - RR2M

2Kg / 2Lt
 Plastic Protective Box
 Box Dimensions: 480x190x130 mm



CODE 0132096

MBK13 - TH02 - 03 - 00

6Kg / 6Lt
Plastic Protective Box (Suitable for trucks,
 road tankers, buses etc)
 Belts for Fire Extinguishers are Included.
Dimensions: 620x335x240 mm

STRETCHY BLACK STRING



CODE 0133015

KX06 - 090A - 130

Stretchy Black Spare String
 for Protective Boxes (p. 212).



SPARE PARTS FOR FIRE EXTINGUISHERS AND FIRE SUPPRESSION SYSTEMS

PROTECTIVE BOX FOR FIRE EXTINGUISHERS



CODE 0132107

MBK14 - PCASE - 9

9Kg / 12Kg & 9Lt

Plastic Protective Box

(Suitable for Trucks, Road Tankers, Buses etc)

Belts for Fire Extinguishers are Included.

Dimensions: 715x335x240 mm



CODE 0132062

KX - TH02 - 01 - 00

6Kg / 9Kg / 12Kg & 6Lt / 9Lt & 5Kg CO₂

Plastic Protective BOX HEAVY Duty

(Suitable for trucks, road tankers, buses etc). Sealing Rubber and Also Belts for Fire

Extinguishers are Included.

Dimensions: 820x270x250 mm



CODE 0132079

MBK10 - TH02 - 04

6Kg / 9Kg / 12Kg & 6Lt / 9Lt & 2Kg CO₂

Double Plastic Box for 2 pcs of Fire Extinguishers

(suitable for buses, trucks etc).

Heavy Duty Straps for Stabilizing the Extinguisher.

Dimensions: 715x540x270 mm.

Convenient Also for 6Lt SCBA 6Lt (MBK10 - BA600)



CODE 0139110

MBK18 - PCASE - TL - 6

6Kg

TOP LOADER Fire Extinguisher Case

for Horizontal Fire Extinguisher Installation in Vehicles.

Suitable for Fire Extinguisher Max Diameter Φ 140 / 160.

Dimensions: 265x284x595mm



PLASTIC PROTECTIVE BOX



CODE 0132108

MBK14 - PCASE - CL - 6

6Kg / 6Lt

Plastic Protective Box (Transparent)

The Fire Extinguisher is Stabilized with Internal
 Metallic Bracket

Dimensions: 640x300x210mm

CODE 0132109

MBK14 - PCASE - CL - 12

9Kg / 12Kg & 9Lt

Plastic Protective Box (Transparent)

The Fire Extinguisher is Stabilized with Internal
 Metallic Bracket

Dimensions: 800x340x240mm

STAINLESS STEEL PROTECTIVE BOX

CODE 0139137

MBK19-SSCABINET-9LT

Stainless Steel Protective Box for 9Lt
 Fire Extinguisher 350x250x800

CODE 0139138

MBK19-SSCABINET-16LT

Stainless Steel Protective Box for 10-16Lt
 Fire Extinguisher 380x280x1100





SPARE PARTS FOR FIRE EXTINGUISHERS AND FIRE SUPPRESSION SYSTEMS

METALLIC PROTECTIVE BOX WITH LOCK

CODE 0139127



NEW

MBK18 - SC - 6

Metal Protective Box for 6kg Fire Extinguisher
Dimensions: 29x72x24cm



CODE 0139128



NEW

MBK18 - SC - 9/12

Metal Protective Box for 9-12kg Fire Extinguisher
Dimensions: 31x87x26cm

POLYESTER PROTECTIVE BOX

Polyester fire extinguisher Protective Box.

Suitable for Outdoor Use and Hard Weather Conditions -
 e.g. Near the Sea.



CODE 0132026

KX15 - EXTC - S1

6Kg / 6Lt

Dimensions: 650x280x225 mm

CODE 0132027

KX15 - EXTC - S2

9Kg / 12Kg & 9Lt

Dimensions: 750x300x225 mm

NYLON PROTECTIVE COVER

Nylon Protective Cover

of High Strength and Water
 Proof for Outdoors installed
 Fire Extinguishers.

UV - Protection



CODE 0133019

KX - TH08 - 01

6Kg / 6Lt / 2Kg CO₂

CODE 0133020

KX - TH08 - 01A

9Kg / 12Kg & 9Lt / 5Kg CO₂



SPARE PARTS FOR FIRE EXTINGUISHERS AND FIRE SUPPRESSION SYSTEMS

HEAVY DUTY PVC COVER

HEAVY DUTY PVC COVER
for the Protection of Fire Extinguishers
in External Rooms.

UV - Protection



CODE 0133047



NEW

MBK18 - TH - 6KG

6Kg & 6Lt & 2Kg CO₂

CODE 0133048



NEW

MBK18 - TH - 9/12KG

9Kg / 12Kg & 9Lt

NYLON PROTECTIVE COVER

Nylon Protective Cover of High Strength and Water Proof
for Outdoors Installed Fire Extinguishers.

UV - Protection



CODE 0133014

KX10 - 343 - 00

25Kg / 25Lt

CODE 0133024

KX - TH08 - 02A

50Kg / 50Lt

CO₂ TROLLEY CARRIAGE

HEAVY DUTY IMPROVED TYPE!
ACCORDING EN 1866 REQUIREMENTS



CODE 0118000

KX11 - 542 - A3

10 Kg

CODE 0118001

KX11 - 547 - A3

25Kg / 30 Kg CO₂

CODE 0118002

KX11 - 550 - A3

45 Kg

CODE 0140008

MBK08 - KX - WHEELSKIT

Service Kit for CO₂ Trolleys
(Wheels - Spare Parts)



CODE 0118014

MBK19 - DOUBLE - CARO

Trolley Suitable for 2pcs Fire Extinguishers
6lt / 9lt & 6kg / 9lt
Cylinder Diameter: 160mm - 180mm
(Fire Extinguishers Are Not Included).



Value in safety... Invest in Quality!

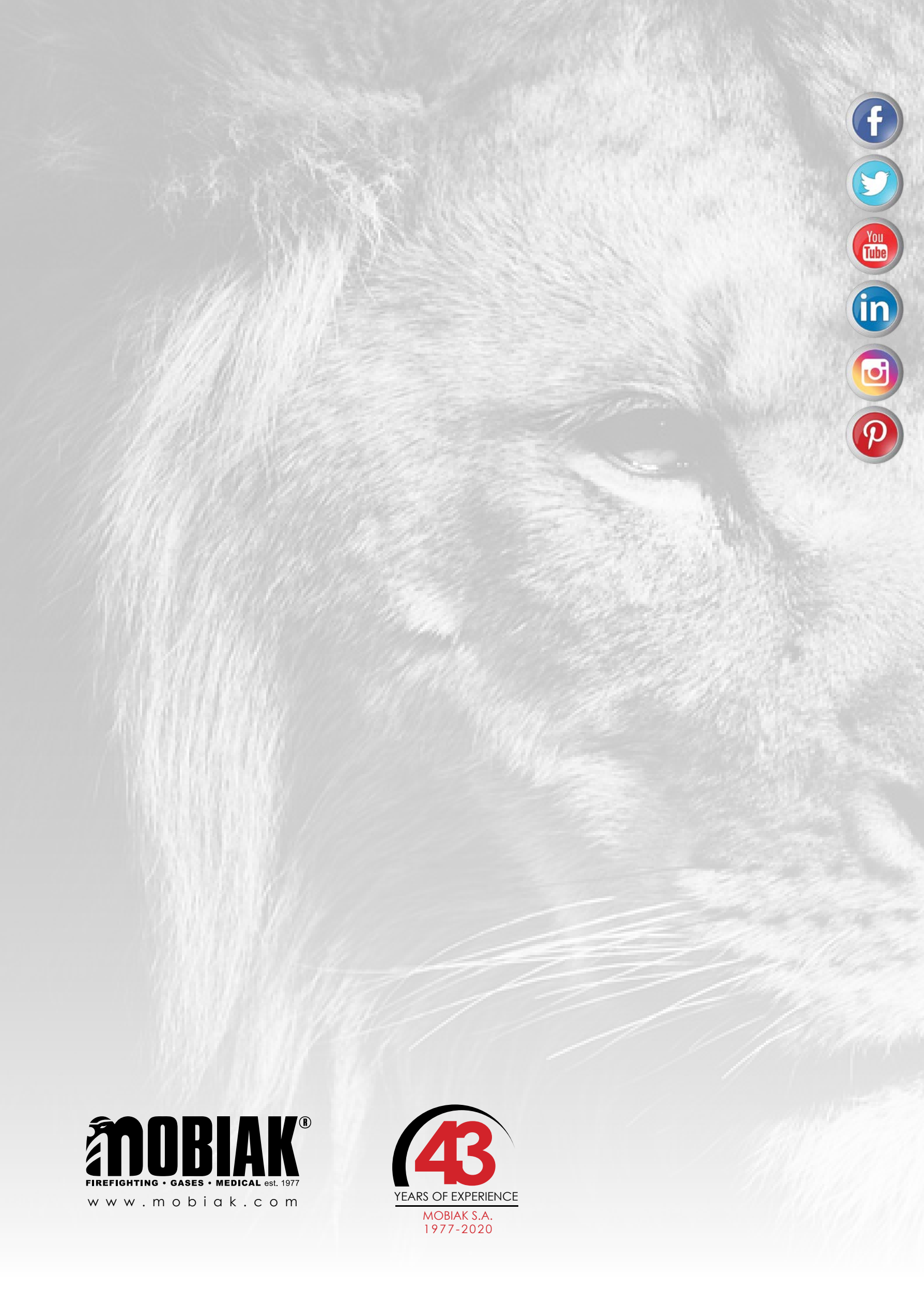

MOBIAK[®]
FIREFIGHTING • GASES • MEDICAL est. 1977
www.mobiaak.com

43
YEARS OF EXPERIENCE
MOBIAK S.A.
1977-2020